

2008

# Quick Guide

---

## Floodplain Management in Texas



**Texas Floodplain Management Association**

<http://www.tfma.org>

This Quick Guide was originally prepared in 2002 by:

RCQUINN  
CONSULTING, INC.

[www.rcquinnconsulting.com](http://www.rcquinnconsulting.com)

# Contents

About This Guide . . . . .	1	Changes to FEMA Flood Maps . . . . .	22
Introduction . . . . .	2	Activities Requiring Permits . . . . .	23
Texas Flood Events . . . . .	3	Safe Uses of the Floodplain . . . . .	24
Why Do We Regulate the Floodplain? . . . . .	4	Is Your Building Site Higher than the BFE? . . . . .	25
What is the National Flood Insurance Program? . . . . .	5	What is Meant by Pre-FIRM and Post-FIRM? . . . . .	26
Flood Insurance: Property Owner’s Best Protection . . . . .	6	Nature Doesn’t Read Maps . . . . .	27
Community Responsibilities . . . . .	7	Think Carefully Before You Seek a Variance . . . . .	28
Looking for Floodplain Information?. . . . .	8	Some Key Permit Review Steps . . . . .	29
FEMA Flood Maps Online. . . . .	9	Carefully Complete the Permit Application . . . . .	30
Flood Map Modernization . . . . .	10	Freeboard: Build Above the BFE . . . . .	31
Understanding the Riverine Floodplain . . . . .	11	What is the Elevation Certificate and How is it Used? . . . . .	32
Understanding the Floodway. . . . .	12	Completing the Elevation Certificate. . . . .	33
Flood Maps . . . . .	13	Paperwork is Important – for You and Your Community . . . . .	34
The Flood Boundary and Floodway Map (Riverine) . . . . .	14	Floodplain Fill Can Make Things Worse . . . . .	35
Old Format Flood Insurance Rate Map (Riverine) . . . . .	15	Recommended Floodway “No Rise” Certification . . . . .	36
Flood Insurance Rate Map (Riverine) . . . . .	16	How to Elevate Your Floodplain Building (Riverine) . . . . .	37
Use the Riverine Flood Profile to Determine BFEs. . . . .	17	Compaction of Floodplain Fill (A Zone) . . . . .	38
Approximate Flood Zones or Unnumbered A Zones . . . . .	18	Basements are Unsafe. . . . .	39
Understanding the Coastal Floodplain . . . . .	19	Manufactured Homes Deserve Special Attention . . . . .	40
Flood Insurance Rate Map (Coastal) . . . . .	20	Enclosures Below the BFE (Riverine) . . . . .	41
Areas of Shallow Flooding . . . . .	21	Typical Elevation Methods for Coastal Buildings . . . . .	42

## Contents, continued

Coastal Houses Must Resist Wind and Water Forces . . . . .	43
Enclosures Below V Zone Building . . . . .	44
The V Zone Certificate (Sample) . . . . .	45
Utility Service Outside Buildings . . . . .	46
Utility Service Inside Enclosures . . . . .	47
Accessory (Appurtenant) Structures . . . . .	48
Recreational Vehicles . . . . .	49
Planning to Improve Your Floodplain Building? . . . . .	50
What About After Damages? . . . . .	51
Elevating a Pre-FIRM Building . . . . .	52
Some Flood Protection for Older Homes is Easy and Low Cost . . .	53
Small Levees and Floodwalls Can Protect Some Older Homes . . .	54
Some Flood Mitigation Projects are More Costly but Give You More Protection . . . . .	55
Be Flood Safe – Don't Drive Through Flooded Roads. . . . .	56
Useful Web Sites and Common Acronyms . . . . .	57
Resources . . . . .	58

## About This Guide

This **Quick Guide** will help you understand more about why and how communities in the State of Texas manage floodplains to protect people and property. Flood-prone communities adopt ordinances that detail the rules and requirements for floodplain development. In case of conflict, that ordinance and not this publication, must be followed. If you have questions, be sure to talk with your local planning, permit, engineering or floodplain management office.

Questions and comments on the Quick Guide can be directed to the Texas Floodplain Management Association (TFMA) at <http://www.tfma.org>.

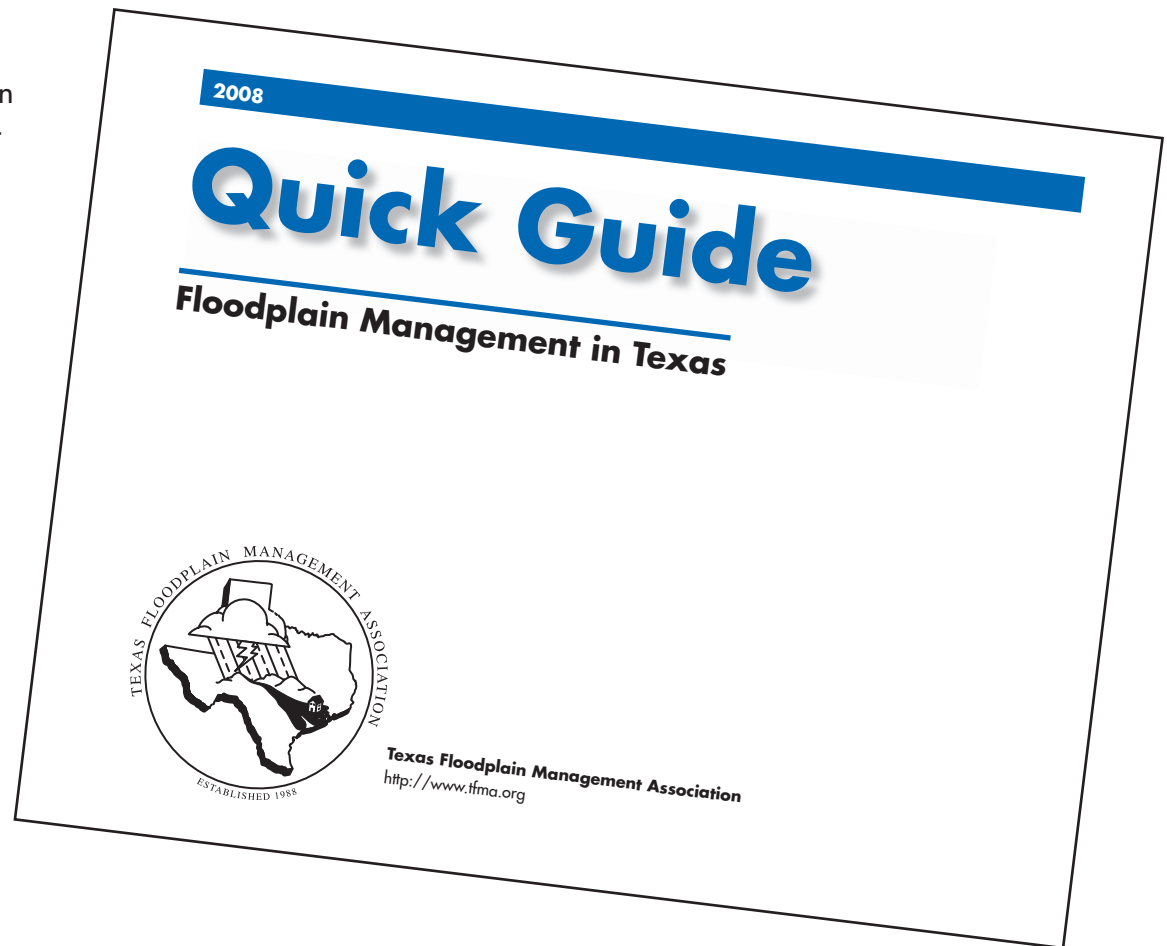

## Introduction

The Texas Floodplain Management Association (TFMA) and its partners are pleased to provide this **Quick Guide** to help citizens understand what floodplain management is and why floodplain development is regulated.

Communities regulate the floodplain to:

- **Protect** people and property
- **Ensure** that Federal flood insurance and disaster assistance are available
- **Save** tax dollars
- **Reduce** future flood losses
- **Reduce** liability

Floods have been, and continue to be, the most destructive natural disaster in terms of economic loss to the citizens of Texas. More than 12% of the state's land area is subject to flooding. Since 1978, Texas flood insurance policy holders have filed over 178,000 flood loss claims totalling \$2.9 billion in claim payments. Even though that represents many insurance payments, most flood-prone Texans don't have flood insurance.



## Texas Flood Events

- Flood-prone areas have been identified in most counties, cities and towns in Texas.
- Millions of structures are located in mapped flood-prone areas.
- Since 1988, over 400 people have died in flood-related incidents and over \$4 billion in damage has occurred.
- About 12% of the state's land area is mapped floodplain. Many waterways have not been mapped.

**Not all flood events are declared major disasters. Many floods are local, affecting only small areas or a few watersheds.**

### Presidential Disaster Declarations 1964-2007\*

#### Number of Declarations by County

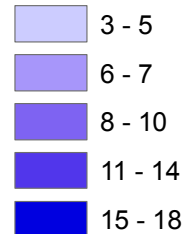

\* FEMA data current to September 2007

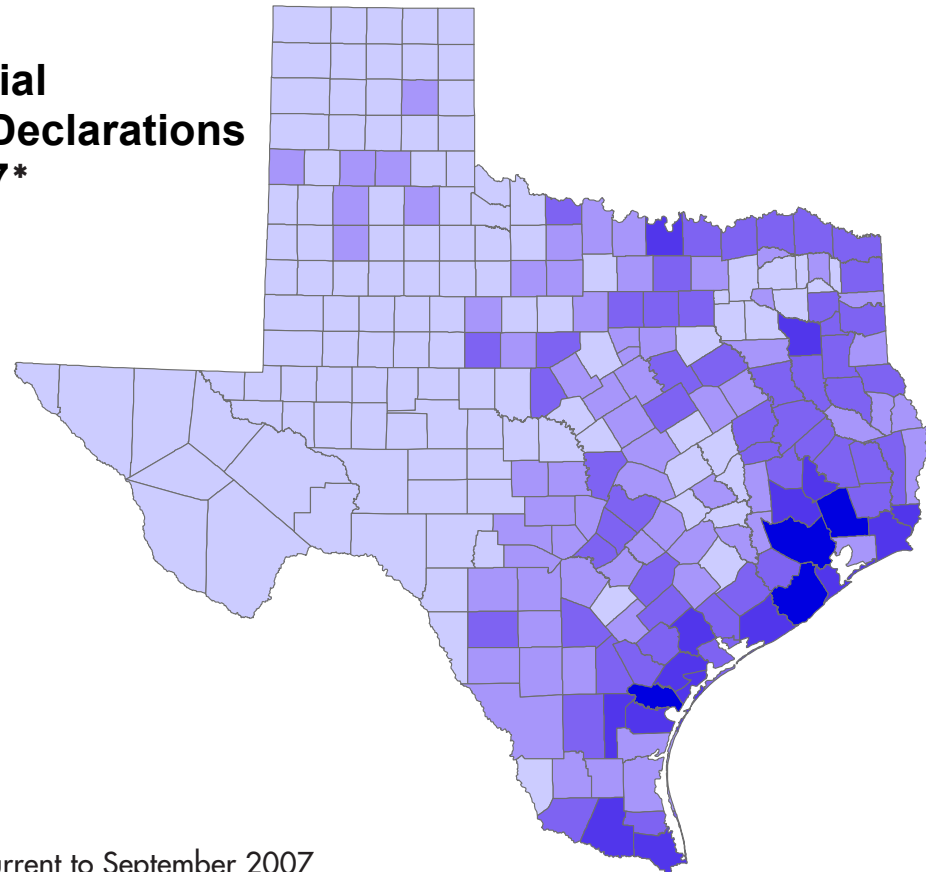

## Why Do We Regulate the Floodplain?

- **To protect people and property.** Floodplain management is about developing smart. It makes good sense. If we know part of our land will flood from time to time, we should make reasonable decisions to help protect our families, homes, and businesses.
- **To make sure that federal flood insurance and disaster assistance are available.** You are not eligible to purchase flood insurance unless you are in a community that regulates development in the floodplain through the NFIP. In addition, if federal flood insurance isn't available, then you can't get some types of federal financial assistance. Home mortgages will be hard to find, and you won't be able to get some types of state and federal loans and grants.
- **To save tax dollars.** Every flood disaster affects your community's budget. If we build smarter, we'll have fewer problems the next time it floods. Remember, federal disaster assistance isn't available for all floods. And even when the President declares a disaster, you and your community still have to pay a portion of the costs of evacuation, temporary housing, repair, and clean-up.
- **To avoid liability and law suits.** If we know an area is mapped as floodplain and likely to flood, if we know people could be in danger, and if we know that buildings could be damaged, it makes sense to take reasonable protective steps when we develop and build.
- **To reduce future flood losses in Texas.** Development that complies with the minimum floodplain management requirements is better protected against major flood-related damage. State legislation was amended in 1999 to require all cities and counties to adopt ordinances or orders to become eligible to participate in the NFIP. Communities in Texas also have authority to regulate development with stricter local floodplain management requirements.



## What is the National Flood Insurance Program?

The National Flood Insurance Program (NFIP) was created by Congress in 1968 to protect lives and property and to reduce the financial burden of providing disaster assistance. The NFIP is administered by the Federal Emergency Management Agency (FEMA).

The NFIP is based on a mutual agreement between the Federal Government and communities. Communities that participate agree to regulate floodplain development according to certain criteria and standards. The partnership involves:

- **Flood hazard maps.** FEMA prepares maps that are used by communities, insurance agents and others.
- **Flood insurance.** Property owners in participating communities are eligible to purchase federal flood insurance for buildings and contents.
- **Regulations.** Communities must agree to adopt and enforce floodplain management regulations so that development, including buildings, is undertaken in ways that reduce exposure to flooding.

To learn more about the NFIP, including your potential flood risk and the approximate cost of a flood insurance policy, go to FEMA's FloodSmart Web site at <http://www.floodsmart.gov>.



## Flood Insurance: Property Owner's Best Protection

Who needs flood insurance? **EVERYONE**. Every homeowner, business owner, and renter in Texas communities that participate in the National Flood Insurance Program may purchase a flood insurance policy — **regardless** of the location of the building. A typical homeowners insurance policy does not cover flood insurance.

Unfortunately, it's often after a flood that many people discover that their homeowner or business property insurance policies do not cover flood damages. Approximately 25% of all flood damages occur in low risk zones, commonly described as being "outside the mapped flood zone."

The Texas Floodplain Management Association and the State of Texas urge YOU to protect your financial future by getting a flood insurance policy. To purchase a policy, call your insurance agent. To get the name of an agent in your community, call the NFIP's toll free number 1 (888) 379-9531 or go to [www.floodsmart.gov](http://www.floodsmart.gov).

Being prepared by having flood insurance will save you money. For a \$50,000 loan at 4% interest, you will pay around \$3,000 per year for 30 years. Compare that to a \$100,000 flood insurance premium, which is about \$700 per year. If your property is in a low risk zone, your premium may be as low as \$112 per year, including coverage for your property's contents.



**NATIONAL  
FLOOD  
INSURANCE  
PROGRAM**

## Community Responsibilities

To participate in the National Flood Insurance Program, your community agrees to:

- **Adopt and enforce** a flood damage prevention ordinance
- **Require** permits for all types of development in the floodplain (see page 23)
- **Ensure** that building sites are reasonably safe from flooding
- **Estimate** flood elevations that were not determined by FEMA
- **Require** new or substantially improved homes and manufactured homes to be elevated above the Base Flood Elevation (BFE)
- **Require** other buildings to be elevated or floodproofed
- **Conduct** field inspections and cite violations
- **Require** Elevation Certificates to document compliance (see pages 32 through 34)
- **Carefully consider** requests for variances
- **Resolve** non-compliance and violations
- **Advise** FEMA when updates to flood maps are needed



**NATIONAL  
FLOOD  
INSURANCE  
PROGRAM**

## Looking for Floodplain Information?

Go to the FEMA Flood Map Store on the Internet at <http://msc.fema.gov>. Digital scans of flood maps can be downloaded or hardcopy maps can be ordered. Reach the Map Store by calling (800) 358-9616.

- FEMA prepares Flood Insurance Studies (FIS) and Flood Insurance Rate Maps (FIRMs) for communities in Texas.
- Most FIRMs show Special Flood Hazard Areas (also called “100-year floodplain” or 1% chance floodplain) and floodways. Some FIRMs show floodplains delineated using approximation analyses (see page 18).
- Not all waterways have designated floodplains – but all waterways will flood, even though a floodplain study may not have been prepared.
- In coastal communities, FIRMs show Special Flood Hazard Areas, including areas subject to wave action (see pages 19 and 20).

**Need a fast answer?** Visit your community’s planning, engineering or permit office where flood maps are available for viewing by the public.

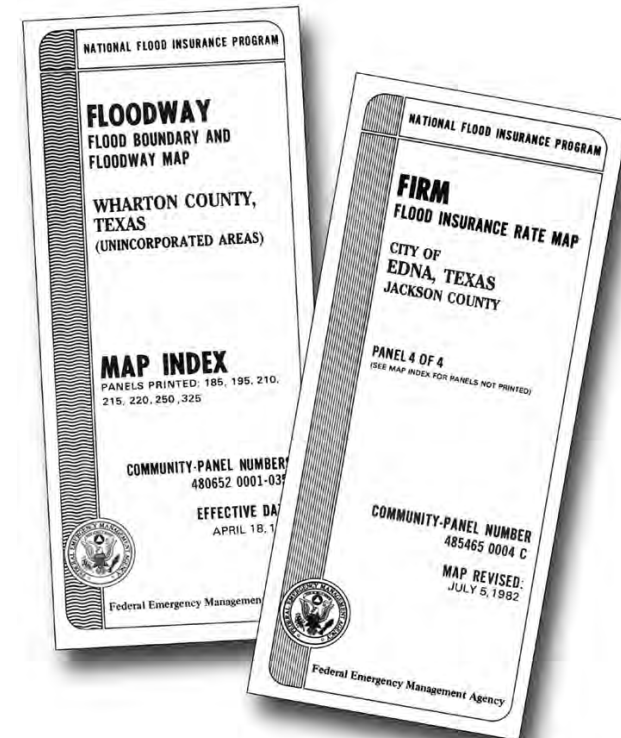

# FEMA Flood Maps Online

You can find and print a FIRM by using online tools at <http://msc.fema.gov>.

- Click the “View” button to display the map panel.
- Once you find your map, use the pan and zoom tools to find the specific area of interest – a miniature map on the left side of the screen shows a red box around the area you are viewing.
- Click the “Make a FIRMette” button and drag the pink translucent box over the area you wish to print.
- Select paper size and Adobe Acrobat (pdf) or Image File (tif).
- Your FIRMette will be displayed and you can print or save the file to your hard drive.

You can also order paper maps or digital maps on CD-ROM from FEMA’s Map Service Center at <http://msc.fema.gov> or (800) 358-9616.

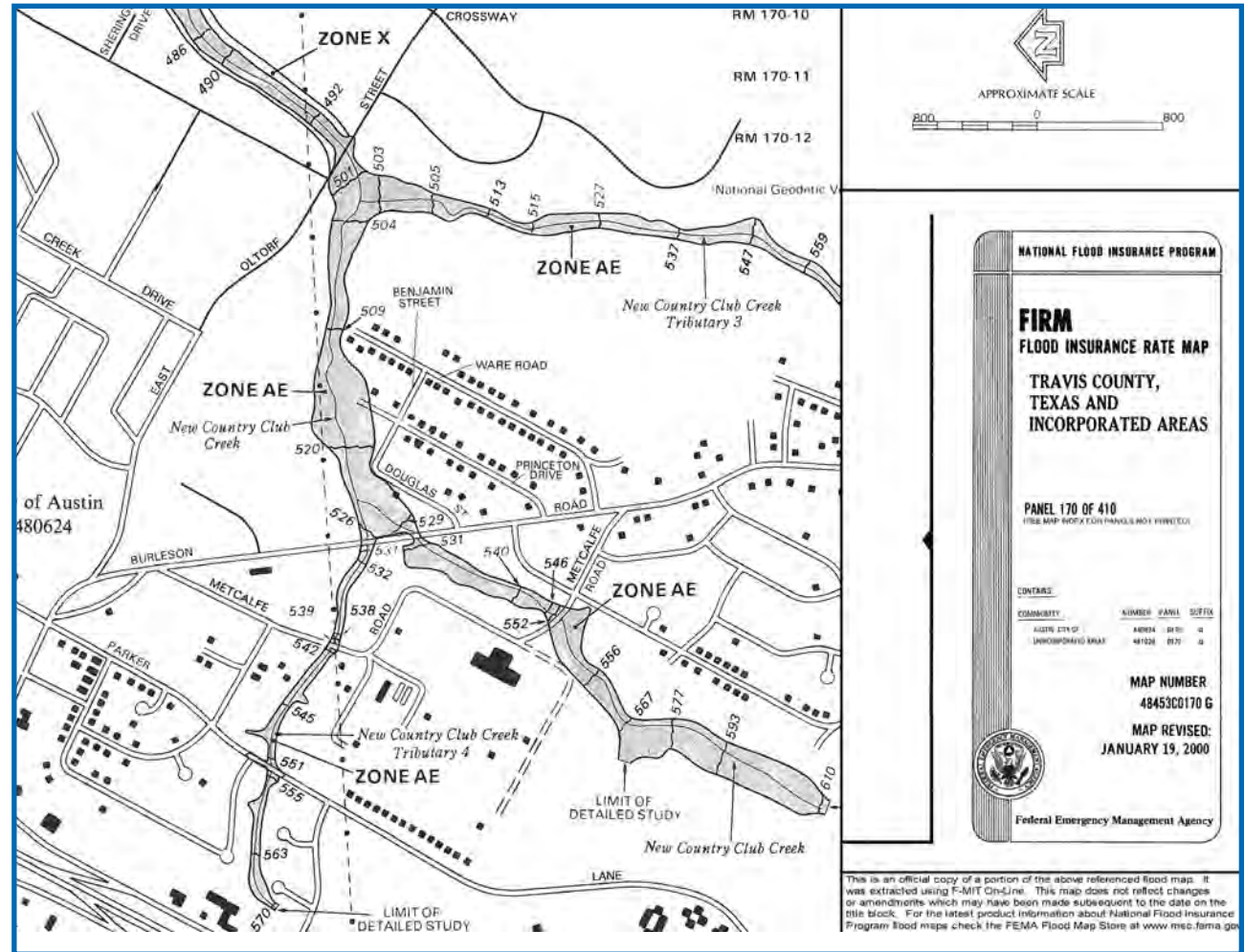

## Flood Map Modernization

The State of Texas, the U.S. Army Corps of Engineers, regional organizations and communities are cooperating to modernize the flood maps.

All new and revised flood maps will be designed to view as paper maps or digitally on a computer within a Geographic Information System (GIS). Flood maps will be composites of base data, topographic data and flood layers which can be overlain with parcel information or other data to more easily determine if a house or other property is or will be located in a Special Flood Hazard Area or Floodway.

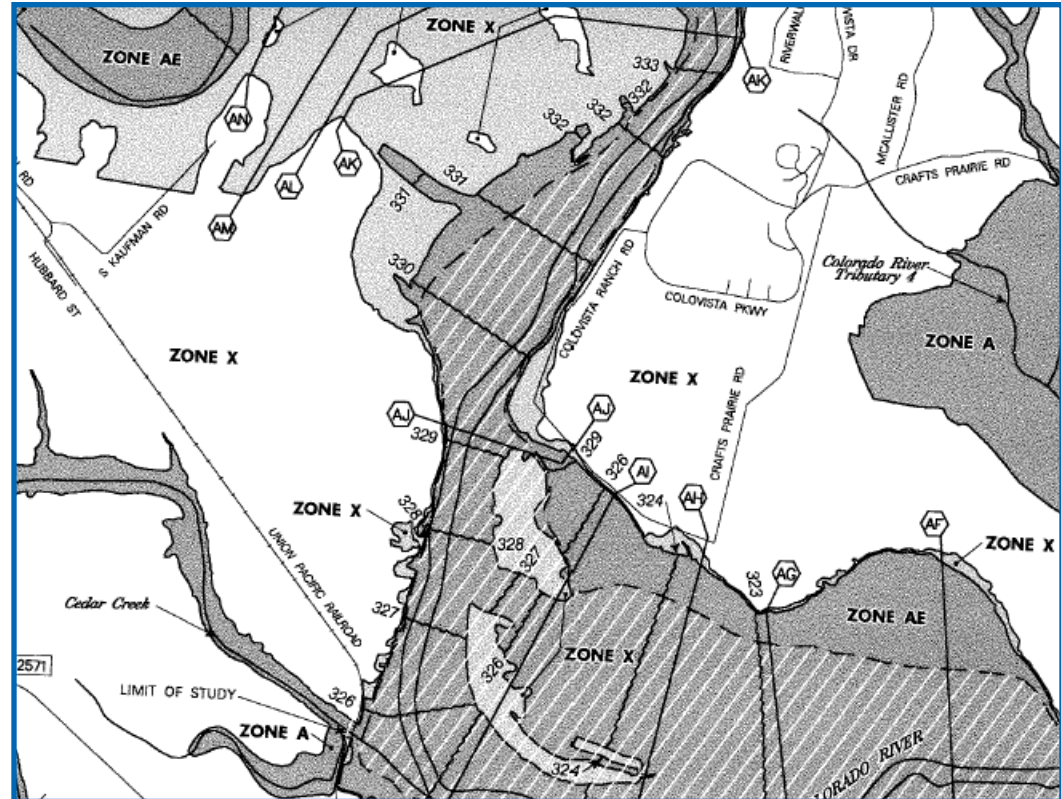

## Understanding the Riverine Floodplain

For floodplains with Base Flood Elevations, check the Flood Insurance Study to find the Flood Profile which shows water surface elevations for different frequency floods (see page 17).

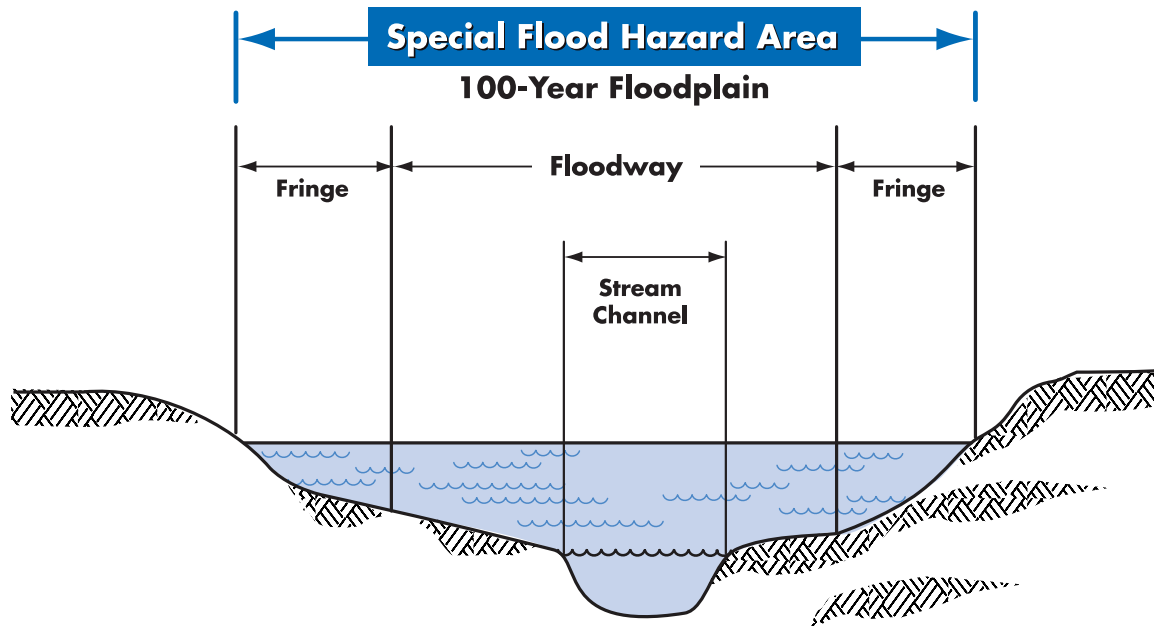

### Terms and Definitions

The Special Flood Hazard Area (SFHA) is that portion of the floodplain subject to inundation by the base flood and/or flood-related erosion hazards. SFHAs are shown on FHBMs or FIRMs as Zones A, AE, A1-A30, AH, AO, AR, V, VE, and V1-V30.

See pages 12, 14 and 16 to learn about the floodway, the area of the floodplain where floodwaters usually flow faster and deeper.

The base flood means the flood having a 1% chance of being equaled or exceeded in any given year (also called "100-year floodplain").

# Understanding the Floodway

For any proposed floodway development, before a local floodplain permit can be issued, the applicant must provide evidence that “no rise” will occur (see page 36). You will need a qualified registered engineer to make sure your proposed project won’t increase flooding on other properties.

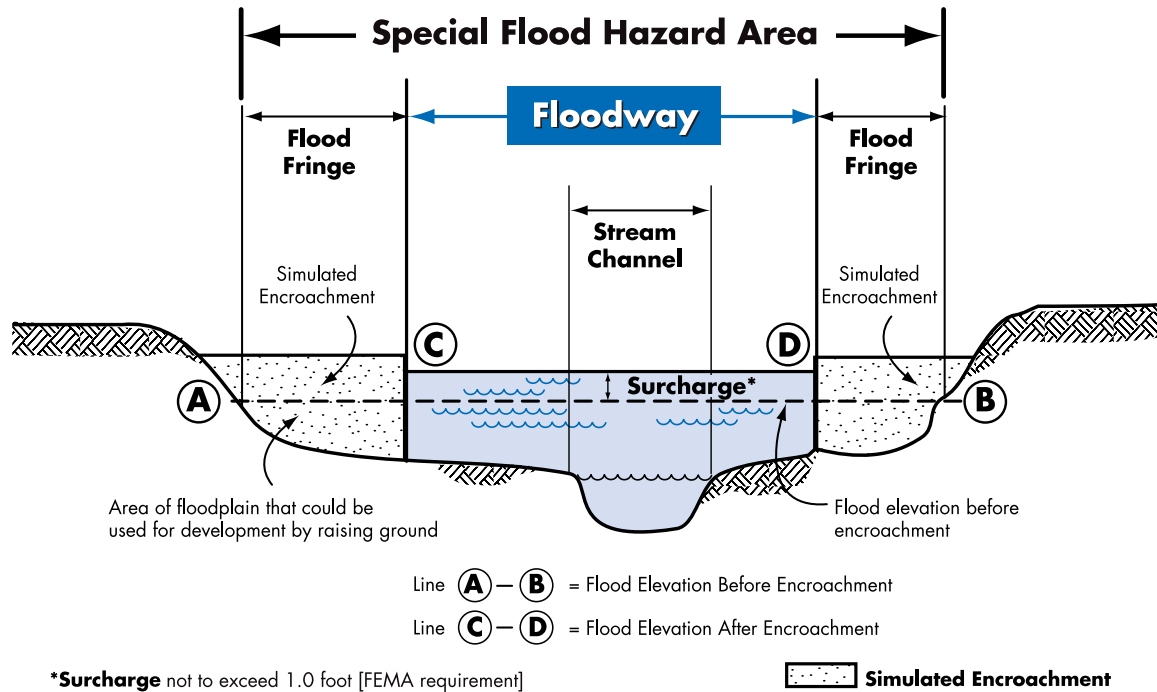

## Terms and Definitions

The Floodway is the channel of a river or other watercourse and the adjacent land areas that must be reserved in order to pass the base flood discharge without increasing flood depths.

Computer models of the floodplain are used to simulate “encroachment” or fill in the flood fringe in order to predict where and how much the base flood elevation would increase if the floodplain is allowed to be filled.



## Flood Maps

FEMA prepares Flood Insurance Rate Maps (FIRMs) to show areas that are at high risk of flooding. Since the 1970s, many versions and updates to maps have been produced.

- “Old format” maps may include flood zones (like B, C, A1-30) that are not being included in map updates. The maps were only available in hard copy and were often accompanied with Flood Hazard Boundary Maps.
- “New format” maps have been produced in order to simplify map zone designations and make map items easier to identify.
- Digital Flood Insurance Rate Maps (DFIRMs) are the product of FEMA’s Map Modernization Program. DFIRMs will update all maps from “old format,” may include new data and information and will be available in digital format for use in computerized mapping and information programs as well as in paper form.

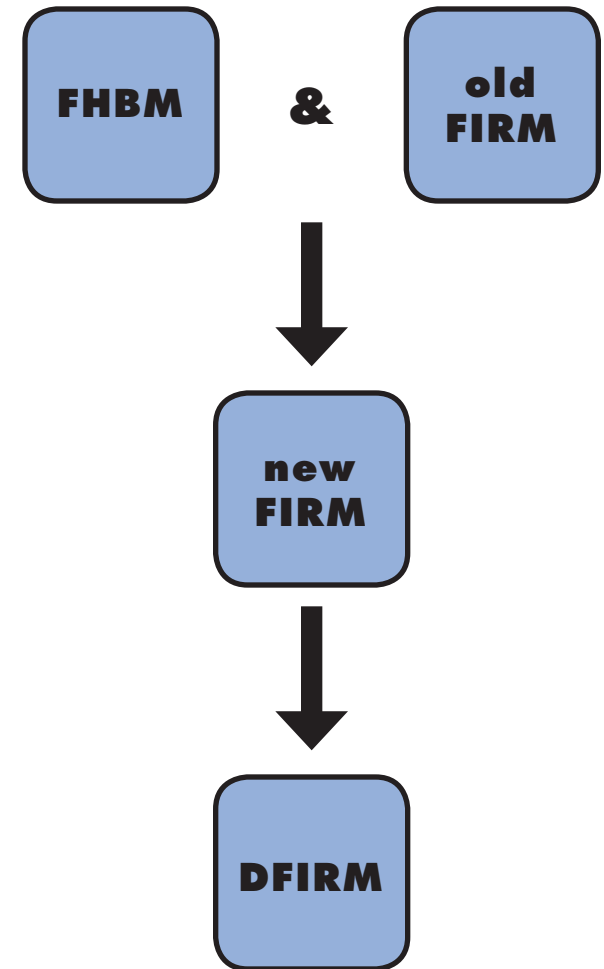

## The Flood Boundary and Floodway Map (Riverine)

FEMA prepares Floodway maps as companions to many FIRMs. Check to see if your project will be in the Floodway because additional engineering may be required (see page 36).



Important

### Information

Initial floodplain maps were flood hazard boundary maps accompanied with separate floodway maps.

Floodway maps do not show flood zones or BFEs. Check the companion FIRM and FIS for that information. Page 15 shows the FIRM that matches the map clip to the left.

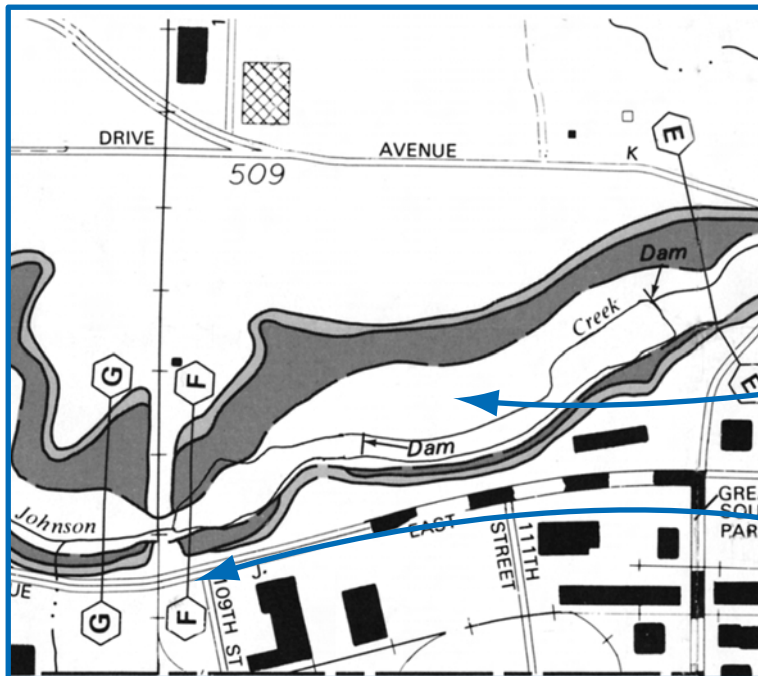

- 1 The Floodway** is the “white” area along the waterway.
- 2 Cross Section** location, where ground surveys determined the shape of the land and how constrictions such as bridges and culverts affect the flow of floodwater.

## Old Format Flood Insurance Rate Map (Riverine)

FEMA prepares Flood Insurance Rate Maps (FIRMs) to show areas that are at high risk of flooding. These are being updated through FEMA's Map Modernization Program.

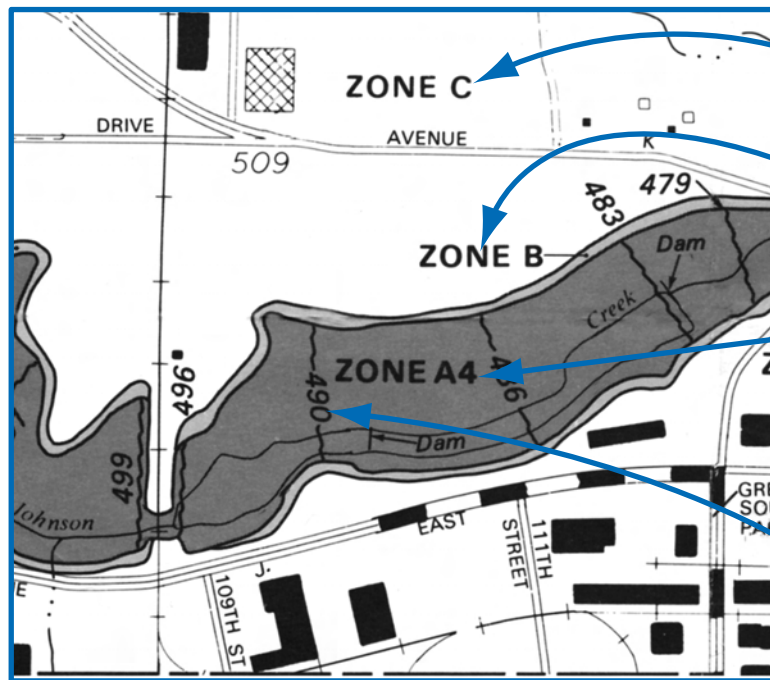

### FLOOD HAZARD ZONES

- 1 Zone C** (or Zone X) is all other areas, considered to be low-risk.
- 2 Zone B** (or shaded Zone X) is subject to flooding by the 500-year flood (0.2% annual chance), and is a moderate risk area.
- 3 Zone A, Zones A1-A30 and Zone AE** are subject to flooding by the base or 100-year flood (1% annual chance), and are considered high-risk areas.
- 4 Base Flood Elevation (BFE).** Water surface elevation of the base flood at specific locations.

## Flood Insurance Rate Map (Riverine)

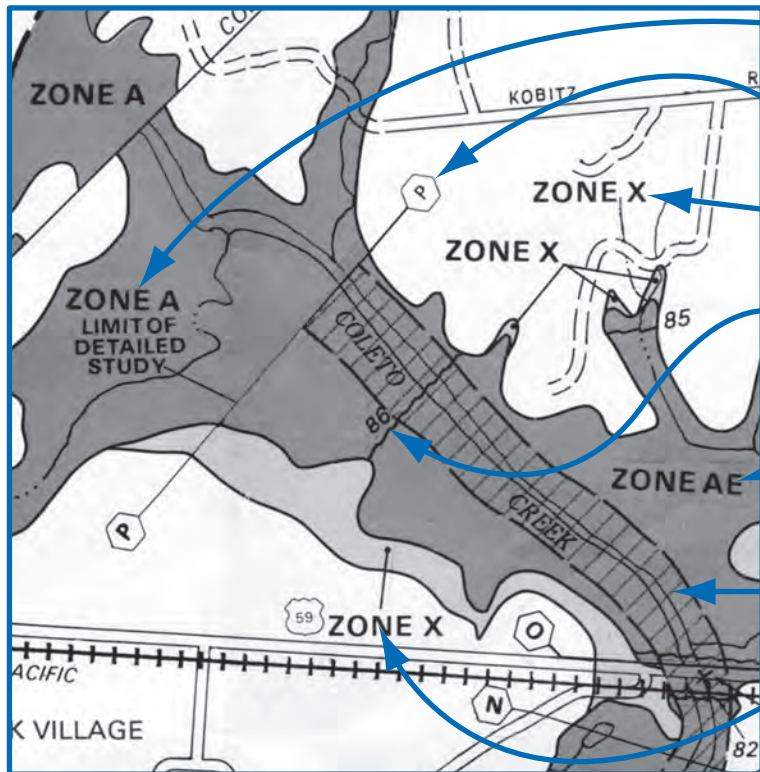

- 1 Zone A** (unnumbered) is flood hazard areas without BFEs.
- 2 Cross Section** location (see page 14).
- 3 Zone X** (unshaded) is all other areas considered low risk (formerly Zone C).
- 4 Base Flood Elevation (BFE)** is the water surface elevation of the base flood at specific locations.
- 5 Zone AE** is the 100-year (1% annual chance) floodplain (also called Zone A1-A30).
- 6 The Floodway** is the "cross-hatched" area.
- 7 Zone X** (shaded) shows low risk areas affected by the 500-year flood (0.2% annual chance) floodplain (also called Zone B).

## Use the Riverine Flood Profile to Determine BFEs

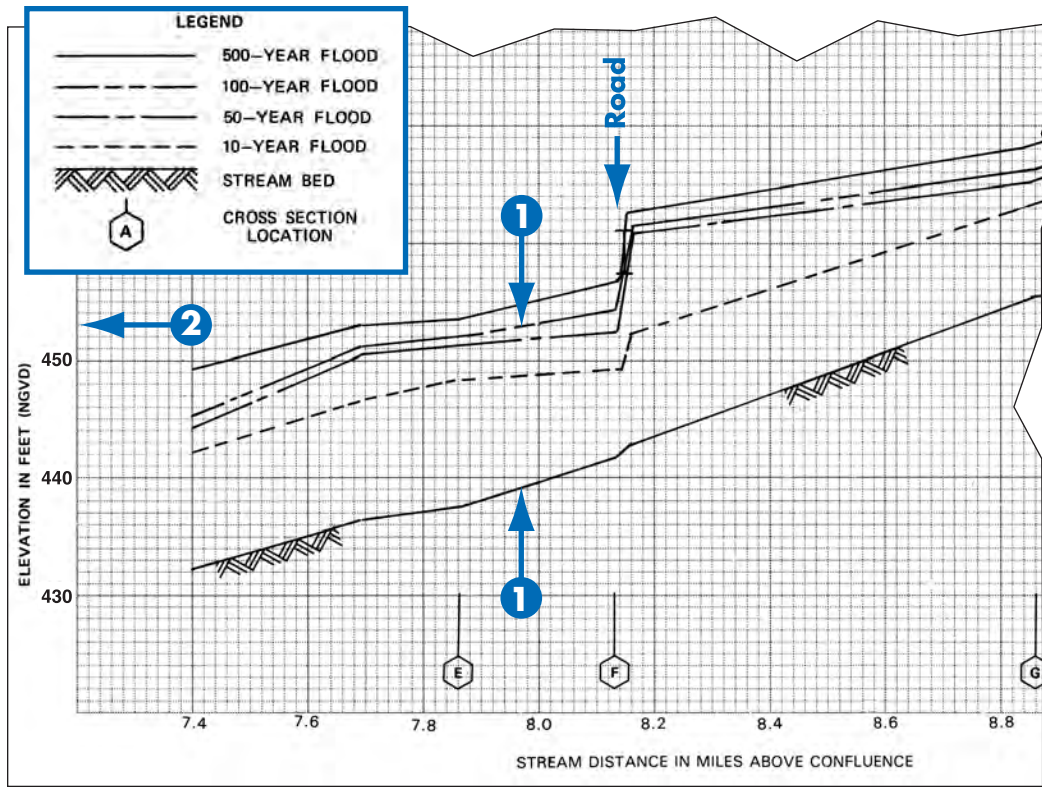

Flood profiles can be used to determine the BFE at a specific site. Profiles also show estimated water surface elevations for floods other than the 1% annual chance flood (100-year flood.)

- 1 On the effective flood map, locate your site by measuring the distance, along the center line of the stream channel, from a road or cross section, for example, **E** or **F**.
- 2 Scale that distance on the Flood Profile and read up to the profile of interest, then across to determine the elevation.

## Approximate Flood Zones and Unnumbered A Zones

Some floodplains are delineated using approximations and therefore do not have specified base flood elevations (BFE). If you need help determining the BFE, check with your community permit office.

FEMA publication *Managing Floodplain Development in Approximate Zone A Areas (FEMA 265)* is useful for engineers and community officials.

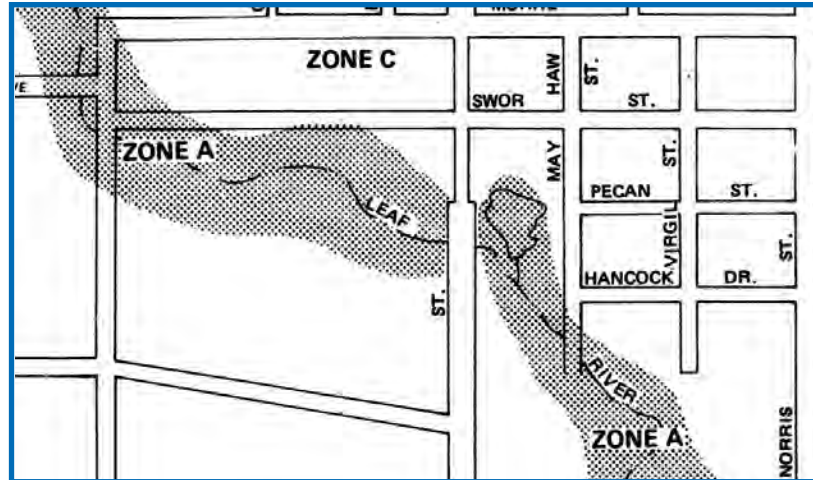

Topographic maps can be used to estimate the Base Flood Elevation if the FIRM shows approximate or unnumbered A Zones.

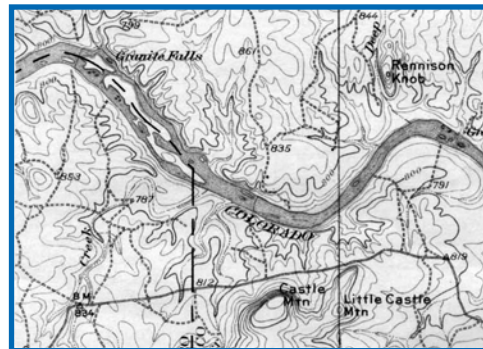

# Understanding the Coastal Floodplain

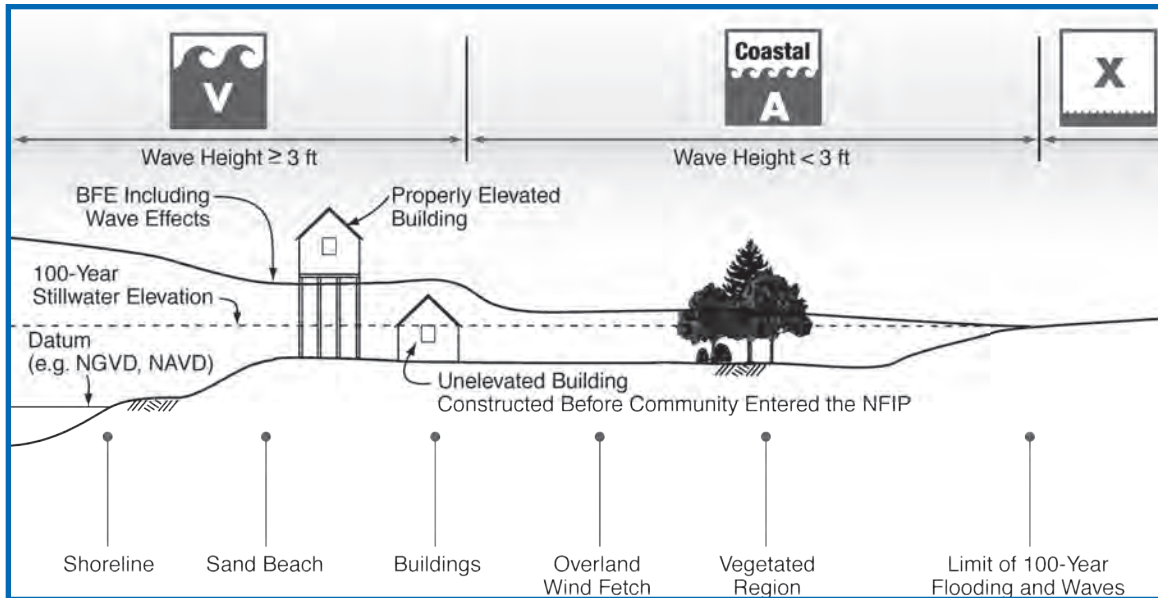

Coastal graphics from Coastal Construction Manual (FEMA 55CD).

## Terms and Definitions

### The Coastal High Hazard Area

**(V Zone)** is the Special Flood Hazard Area that extends from offshore to the inland limit of a primary frontal dune along an open coast and any other area subject to high velocity wave action. The area is designated on the FIRM as Zone V1-V30, VE, or V.

The term **Coastal A Zone** means the portion of the SFHA landward of the V Zone or landward of a shoreline that does not have a mapped V Zone. The principal sources of flooding are associated with astronomical tides, storm surges, seiches or tsunamis. Coastal A Zones may be subject to wave effects, velocity flows, erosion, scour, or combinations of these forces and may be treated as V Zones.

## Flood Insurance Rate Map (Coastal)

This portion of a FIRM shows a coastal Special Flood Hazard Area (SFHA) (dark gray), the 500-year flood hazard area (light gray), coastal Base Flood Elevations (BFEs) (numbers in parentheses), and flood insurance rate zones (AE and VE = SFHA, VE = Coastal High Hazard Area, X = areas outside the SFHA).

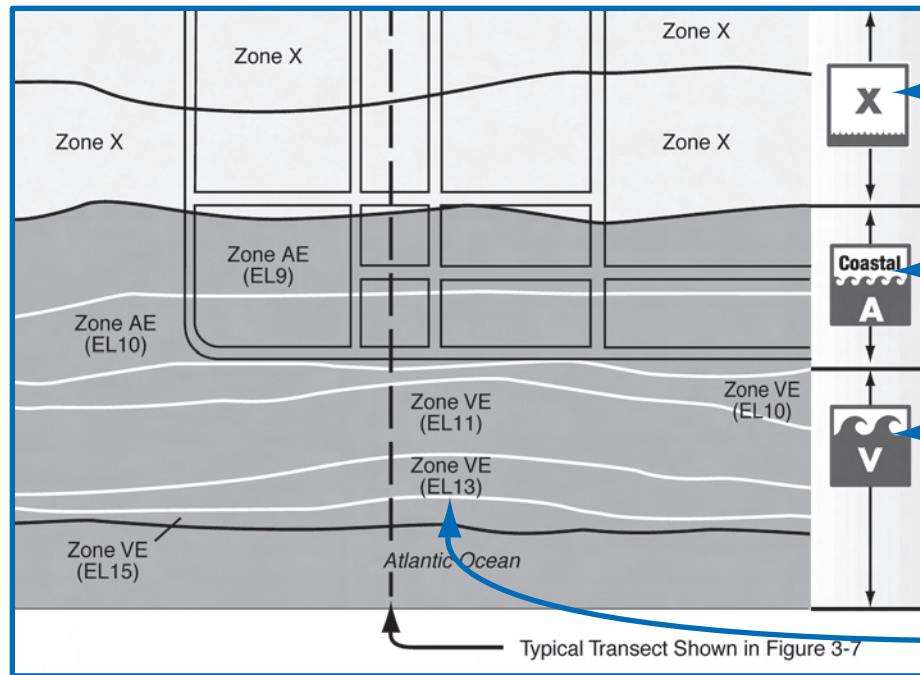

### COASTAL FLOOD HAZARD ZONES

- 2 **Zone X** (unshaded) is all other areas considered low risk (formerly Zone C).
- 1 **Zone A, Zones A1-A30, and Zone AE** are subject to flooding by the base or 100-year flood (1% annual chance), and waves less than 3 feet.
- 3 **Zone V, Zones V1-V30, and Zone VE** are where waves are expected to be 3 feet or more.
- 4 **Base Flood Elevation (BFE).** Water surface elevation (in feet above datum).

### UNDEVELOPED COASTAL BARRIERS



Identified  
1983    Identified  
1990    Otherwise  
Protected  
Areas

In undeveloped Coastal Barrier Resource Areas (COBRA), NFIP insurance is not available for new or substantially improved structures built after November 16, 1990.



## Areas of Shallow Flooding

These are areas with a 1% chance of a shallow flood (1-3 feet) each year.

- Zone AH areas usually flood from ponding in which water is generally not moving across the land.
- Zone AO areas usually flood from sheet flow in which water moves across land where there is no defined channel.

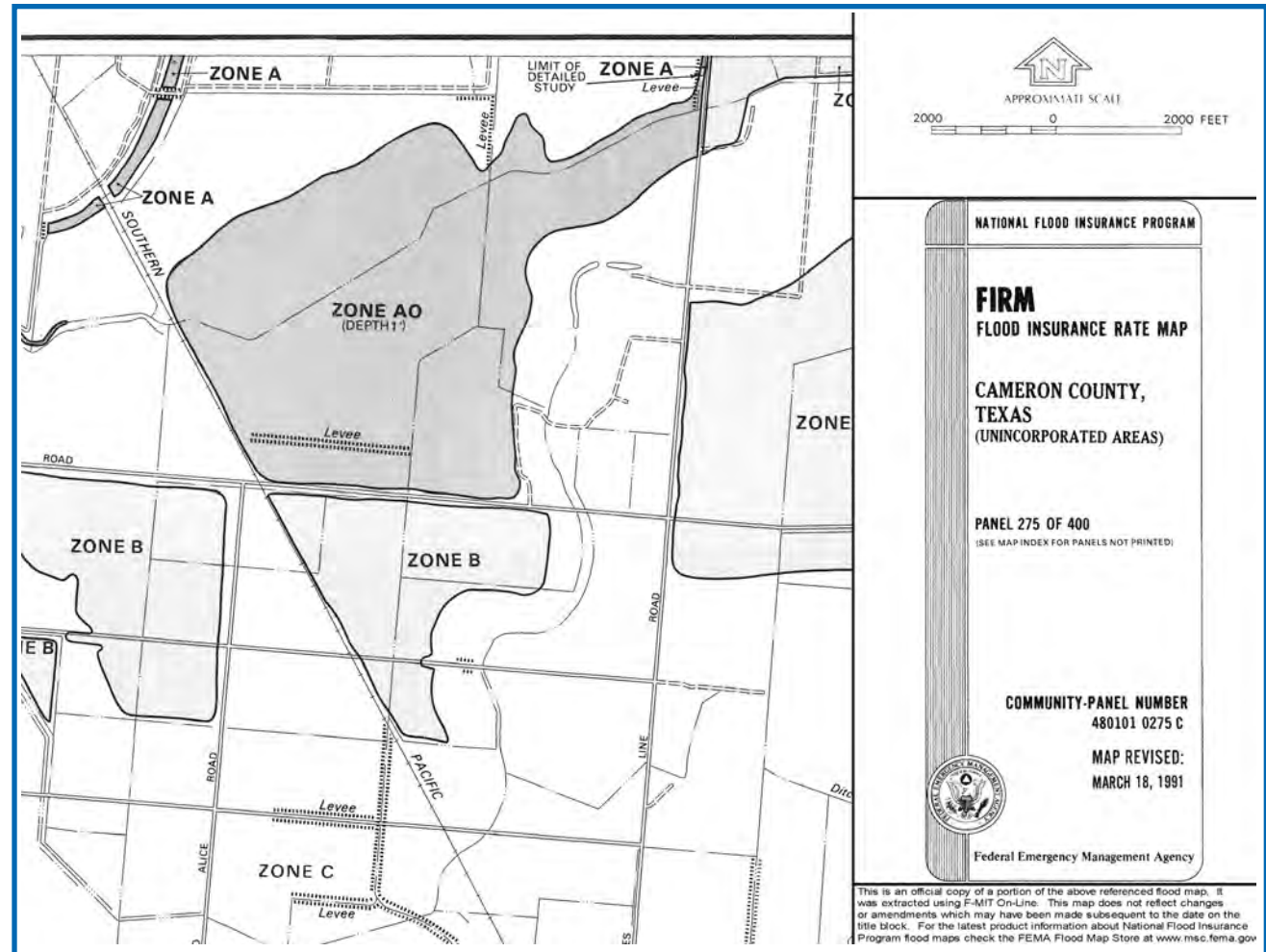

## Changes to FEMA Flood Maps

Most changes to FIRMs are made by Letter of Map Change (LOMC) – a letter which reflects an official revision to an effective NFIP map.

1. **Letter of Map Amendment (LOMA)** is an official amendment to an effective FIRM that may be issued when a property owner provides additional technical information from a licensed land surveyor or engineer, such as ground elevation relative to the BFE, SFHA, and the building. Lenders may waive the flood insurance requirement if the LOMA documents that a building is on ground above mapped floodplain.
2. **Electronic Letter of Map Amendment (eLOMA)** is web based application to submit simple LOMAs to FEMA.
3. **Letter of Map Revision (LOMR)** is an official revision to an effective FIRM that may be issued to change flood insurance risk zones, special flood hazard area and floodway boundary delineations, BFEs and/or other map features. Lenders may waive the insurance requirement if the approved map revision shows buildings to be outside of the SFHA.
4. **Letter of Map Revision Based on Fill (LOMR-F)** is an official revision to an effective FIRM that is issued to document FEMA's determination that a structure or parcel of land has been elevated by fill above the BFE, and therefore is no longer in the SFHA. Lenders may waive the insurance requirement if the LOMR-F shows that a building on fill is above the BFE.

**Physical Map Revision** may be issued for major floodplain changes that require engineering analyses, such as bridges, culverts, channel changes, flood control measures, and large fills that change the BFE or Floodway. Physical map revisions are also issued when a new study updates or improves the FIRM.

**Requests for map revisions must be coordinated through your community.**

## Activities Requiring Permits

Most man made changes to land in the floodplain requires a permit. Examples include:

- Constructing new buildings (including temporary or agricultural)
- Additions to existing buildings
- Substantial improvements to existing buildings (including interior renovation)
- Repair of substantially damaged buildings
- Placement of manufactured (mobile) homes
- Subdivision of land
- Parking or storage of recreational vehicles
- Storing materials, including gas/liquid tanks
- Construction of roads, bridges and culverts
- Placement of fill, grading, excavation, mining and dredging
- Alteration of stream channels
- Oil and gas drilling



## Safe Uses of the Floodplain

Let the floodplain do its job – if possible, keep it natural open space. Other low damage uses may include recreational areas, playgrounds, reforestation, parking, gardens, pasture, accessory structures, created wetlands, ecosystem restoration and wildlife management.

### RECOMMENDED

All land subdivided into lots, some lots partially in the floodplain, setbacks modified to keep homesites on high ground.

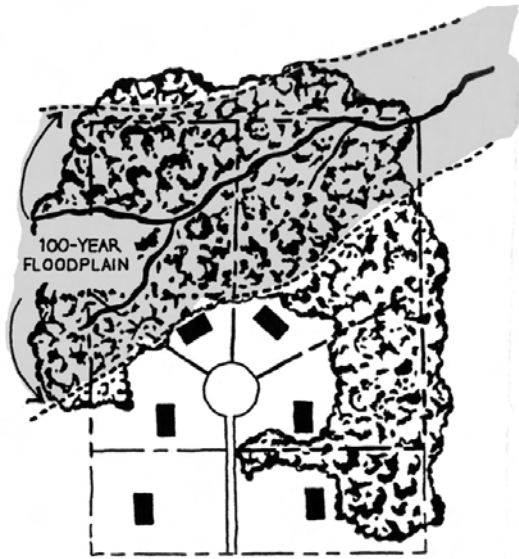

### RECOMMENDED

Floodplain land put into public/common open space, net density remains, lot sizes reduced and setbacks modified to keep homesites on high ground.

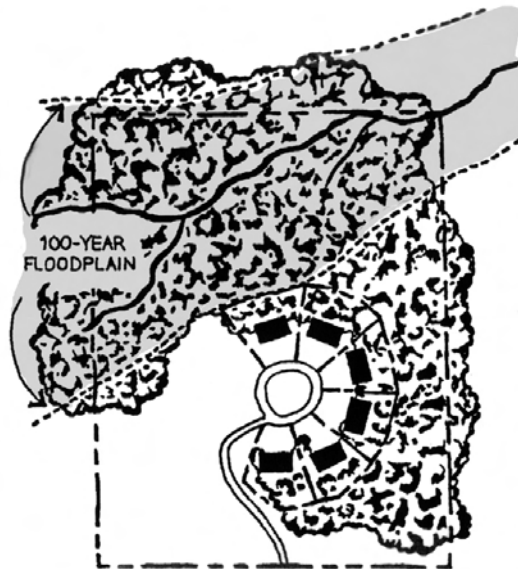

### NOT RECOMMENDED

All land subdivided into lots, some homesites and lots partially or entirely in the floodplain.

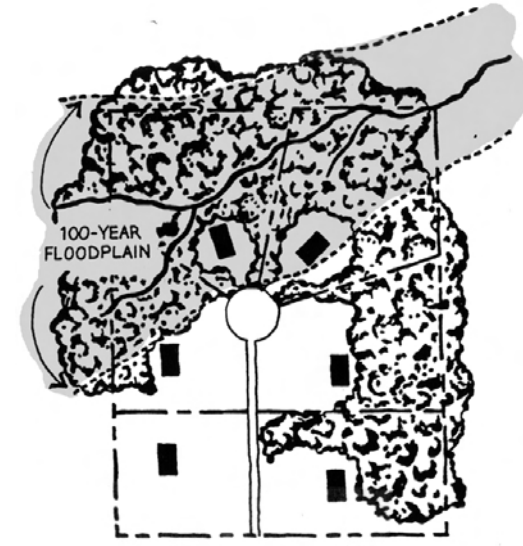

## Is Your Building Site Higher than the BFE?

If your land is shown on the map as “in” the regulatory floodplain, but your building site is higher than the Base Flood Elevation (BFE)... get a licensed land surveyor or engineer to complete a FEMA Elevation Certificate (EC). Submit the EC with an application for a Letter of Map Amendment to FEMA to verify that your property is above the BFE. If approved, it will remove the mandatory federal requirement to purchase flood insurance if you have a federally backed mortgage. Keep the certificate with your deed, it will help future buyers.

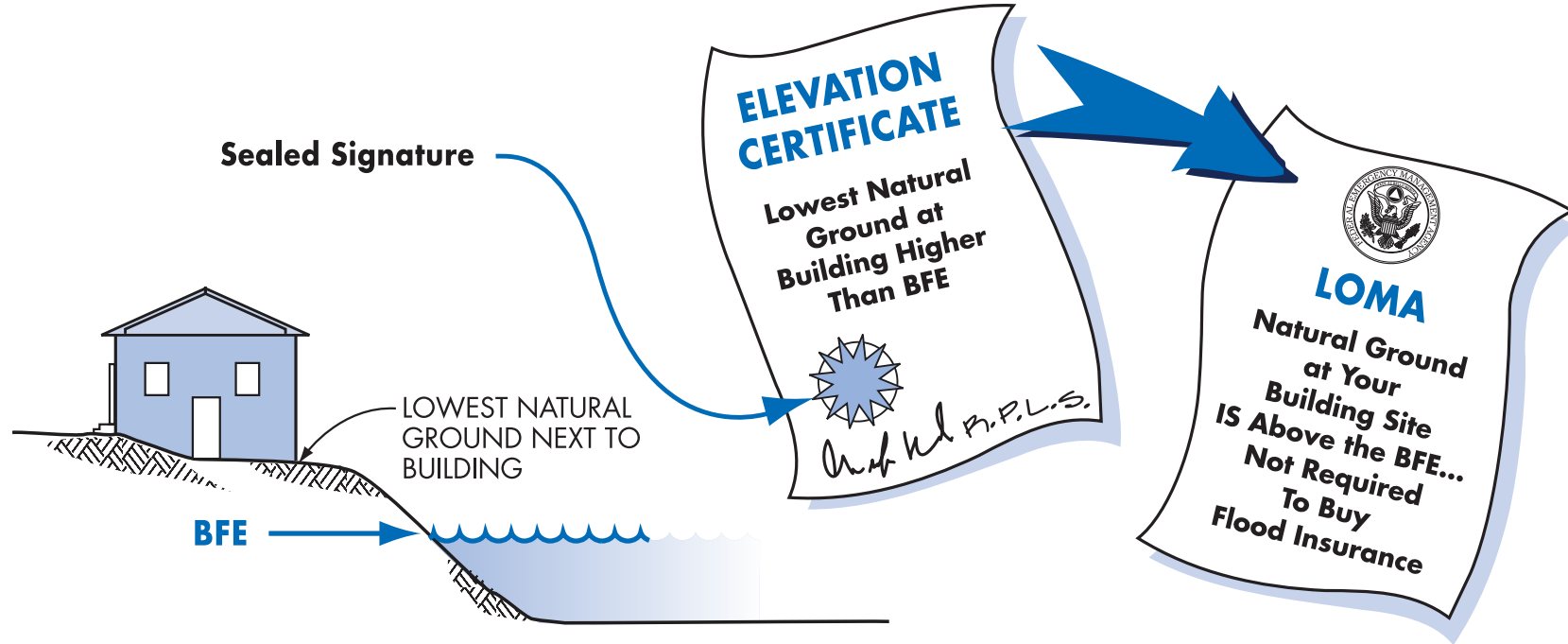

## What is Meant by Pre-FIRM and Post-FIRM?

A building is Pre-FIRM if it was built before the date of your community's first FIRM or before December 31, 1974. If built after that date, a building is Post-FIRM.

Improvements or repairs to Pre-FIRM buildings may require permits (see pages 29 and 30).

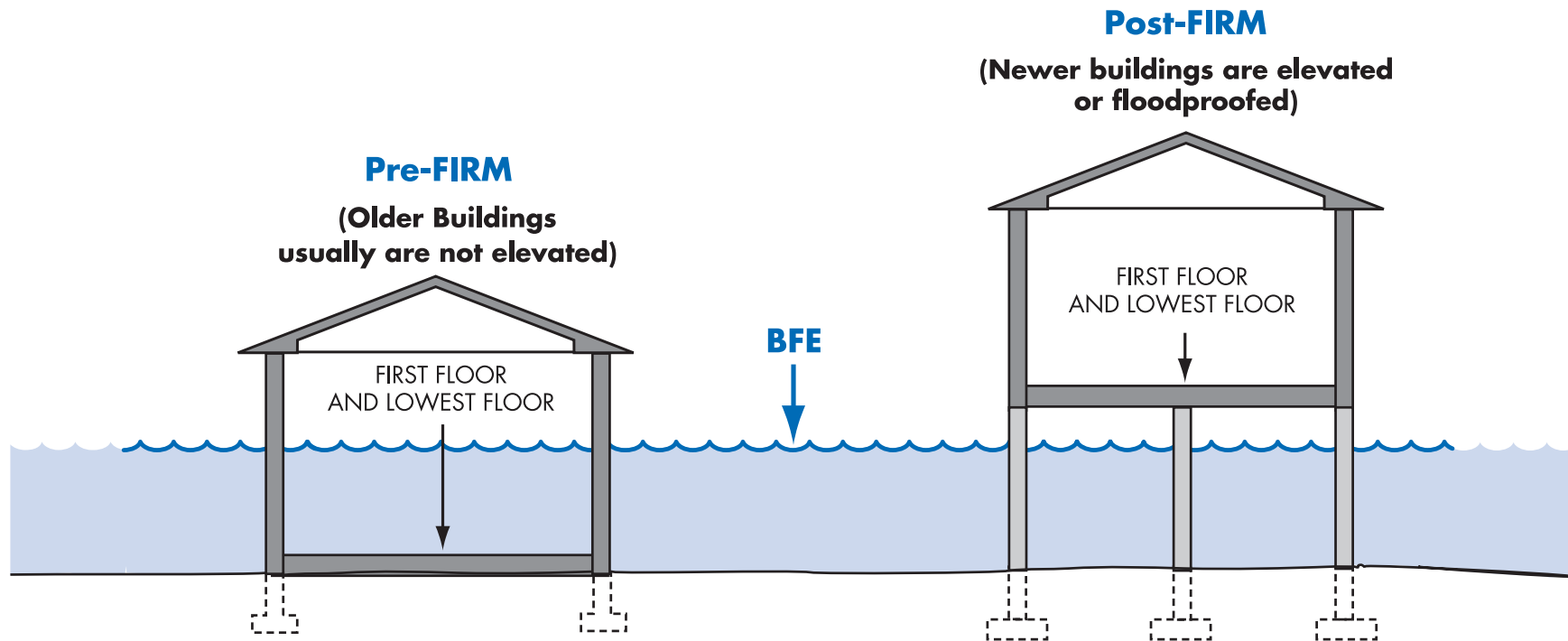

## Nature Doesn't Read Maps



Important

### Information

Many people don't understand just how risky the floodplain can be. There is a 26% chance that a non-elevated home in the floodplain will be damaged during a 30-year mortgage period. The chance that a major fire will occur during the same period is less than 5%.

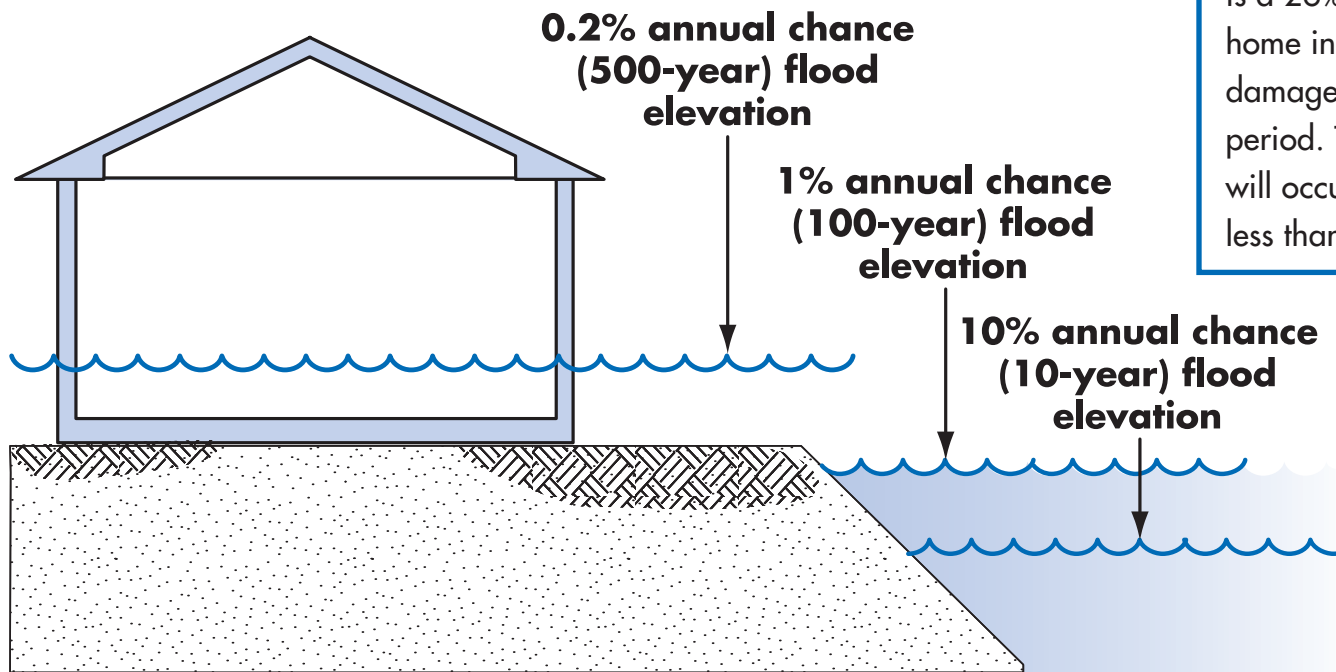

**CAUTION:** Nature doesn't read the flood map. Major storms and flash floods can cause flooding that rises higher than the 100-year elevation (BFE). Consider safety – protect your home or business by building higher. See page 31 to see how this will save you money on insurance.

## Think Carefully Before You Seek A Variance

Very specific conditions must be satisfied to justify a variance:

- Good and sufficient cause
- Unique site conditions
- Individual non-economic hardship
- If in the floodway, no increase in flood level

A variance that allows construction below the BFE does not waive your lender's flood insurance requirement. Flood insurance will be very expensive – perhaps more than \$3,000 per year as compared to less than \$500 (see page 31).

**Think carefully about seeking a variance to build below the Base Flood Elevation. Not only will your property be more likely to get damaged, but insurance will be very costly.**

**If your community has a pattern of inconsistent variances, FEMA sanctions can be imposed – costing you even more.**

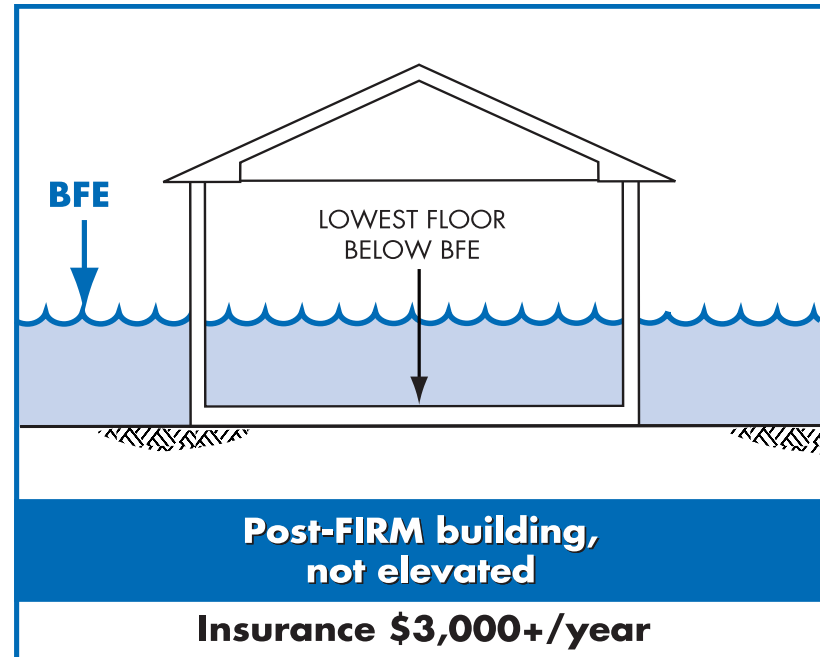



## Some Key Permit Review Steps

The Permit Reviewer has to check many things. Some of the key questions are:

- Is the site in the mapped floodplain?
- Is the site in the mapped floodway?
- Have other local, state and federal permits been obtained (septic, water quality, wetland)?
- Is the site reasonably safe from flooding?
- Does the site plan show the Base Flood Elevation, development location and the floodplain delineation?
- Is substantial improvement of an older building proposed?
- Is an addition proposed?
- Will new buildings and utilities be elevated properly?
- Will manufactured homes be properly elevated and anchored?
- Do the plans show an appropriate and safe foundation?
- Will an Elevation Certificate be required?



# Carefully Complete the Permit Application



You must get a permit **before** you do work in a floodplain.

## FLOODPLAIN DEVELOPMENT PERMIT *(partial)*

OWNER DAVID & SALLY JONES  
 ADDRESS 781 REED STREET

### PROJECT DESCRIPTION

- |   |   |  |
|---|---|--|
| <input checked="" type="checkbox"/> Single Family Residential | <input checked="" type="checkbox"/> New Construction    | <input type="checkbox"/> Channelization  |
| <input type="checkbox"/> Multi-Family Residential             | <input type="checkbox"/> Substantial Improvement (>50%) | <input checked="" type="checkbox"/> Fill |
| <input type="checkbox"/> Manufactured (Mobile) Home           | <input type="checkbox"/> Improvement (<50%)             | <input type="checkbox"/> Bridge/Culvert  |
| <input type="checkbox"/> Non-Residential                      | <input type="checkbox"/> Rehabilitation                 | <input type="checkbox"/> Levee           |
| <input type="checkbox"/> Other/Explanation _____              |   |  |

### FLOOD HAZARD DATA

Watercourse Name DRY RIVER  
 The project is proposed in the \_\_\_\_\_ Floodway  Floodway Fringe  
 Base (100-year) flood elevation(s) at project site 59.2  
 Elevation required for Lowest Floor 60.2 /Floodproofing \_\_\_\_\_

Rebecca Reviewer, CFM \_\_\_\_\_ 4/2/2007  
 Floodplain Administrator's Signature Date

Good information will lead to better construction and less exposure to future flood damage.

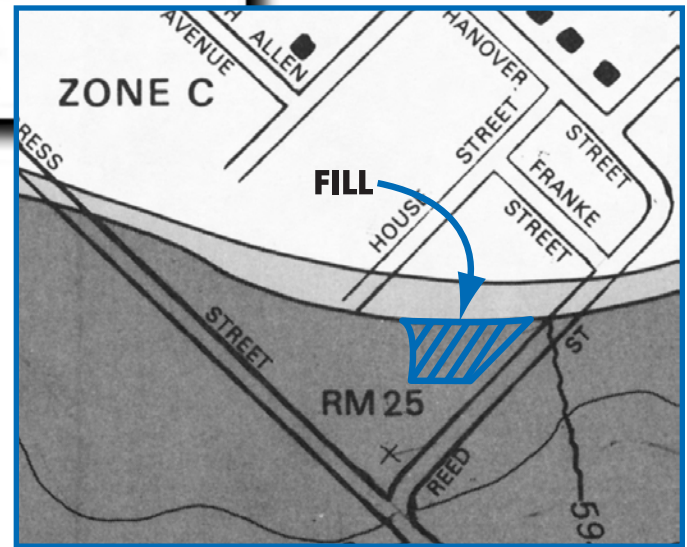

## Freeboard: Build Above the BFE

Want to save some money and have peace of mind at the same time? Then add Freeboard to build higher than the minimum elevation requirement. Freeboard is a factor of safety, usually one or two feet above the BFE. Freeboard tends to compensate for the many unknown factors that could contribute to flood heights greater than the BFE.

Annual Flood Insurance Cost	
<b>If you have:</b>	
<input checked="" type="checkbox"/>	a post-FIRM structure
<input checked="" type="checkbox"/>	in an AE Zone
<input checked="" type="checkbox"/>	with \$250,000 structural coverage (maximum)
<input checked="" type="checkbox"/>	with \$100,000 contents (maximum)
<b>The approximate annual cost for flood insurance:</b>	
+3 ft.	\$500
+2 ft.	\$550
+1 ft.	\$700
BFE	\$1,100
-1 ft.	\$5,000
-2 ft.	expensive (submit for rate)



### Important

### Information

**NOTE:** Flood insurance rates and various fees change from time to time. Rather than specific costs for insurance, this figure gives a feel for how much difference just a foot or two can make.

Building owners will save insurance money if they elevate above the BFE. But more impressive is how the cost of insurance can more than double if the building is only one foot below the BFE.

### Remember:

The community may be able to grant a variance, but the owner will probably still be required to buy insurance. Imagine trying to sell a house if the bank requires insurance that costs about \$5,000 a year.

## What is the Elevation Certificate and How is it Used?

- The Elevation Certificate (EC) is a FEMA form used to record building elevation site conditions and FIRM information for a development site. Go to <http://www.fema.gov/library/> and search for “Elevation Certificate.”
- The EC must be completed and sealed by a licensed surveyor or engineer.
- A community official or property owner may complete the EC for sites in approximate flood zones and AO Zones.
- It can be used to show that the ground at a development is above the Base Flood Elevation (see page 25).
- It is used to verify that buildings are elevated properly (see pages 29 and 34).
- Insurance agents use the EC to write and rate flood insurance policies.

**By itself, the EC cannot be used to waive the requirement to get flood insurance. See page 25 to learn about Letters of Map Amendment.**

The image shows two FEMA Elevation Certificate forms. The top form is the cover sheet, titled "Elevation Certificate and Instructions", issued by the Federal Emergency Management Agency National Flood Insurance Program. The bottom form is the main "ELEVATION CERTIFICATE" form, which is divided into several sections: SECTION A - PROJECT DATA INFORMATION, SECTION B - FLOOD INSURANCE RATE MAP (FIRM) INFORMATION, SECTION C - BUILDING ELEVATION INFORMATION (SURVEY REQUIREMENTS), and SECTION D - SURVEYOR, ENGINEER, OR ARCHITECT CERTIFICATION. The form includes various fields for project details, flood insurance information, and a checklist of requirements for building elevations.

# Completing the Elevation Certificate

## Elevation Certificate (partial)

### SECTION C - BUILDING ELEVATION INFORMATION (SURVEY REQUIRED)

C1. Building elevations are based on:  Construction Drawings\*  Building Under Construction\*  Finished Construction

\*A new Elevation Certificate will be required when construction of the building is complete.

C2. Elevations – Zones A1-A30, AE, AH, A (with BFE), VE, V1-V30, V (with BFE), AR, AR/A, AR/AE, AR/A1-A30, AR/AH, AR/AO. Complete Items C2.a-g below according to the building diagram specified in Item A7.

Benchmark Utilized RM66

Vertical Datum NAVD 88

Conversion/Comments none

Check the measurement used.

- |  |               |  |  |
|--|---------------|--|--|
| a) Top of bottom floor (including basement, crawl space, or enclosure floor)                                     | <u>286.00</u> | <input checked="" type="checkbox"/> feet | <input type="checkbox"/> meters (Puerto Rico only) |
| b) Top of the next higher floor  | <u>n/a</u>    | <input type="checkbox"/> feet            | <input type="checkbox"/> meters (Puerto Rico only) |
| c) Bottom of the lowest horizontal structural member (V Zones only)  | <u>n/a</u>    | <input type="checkbox"/> feet            | <input type="checkbox"/> meters (Puerto Rico only) |
| d) Attached garage (top of slab)   | <u>282.5</u>  | <input checked="" type="checkbox"/> feet | <input type="checkbox"/> meters (Puerto Rico only) |
| e) Lowest elevation of machinery or equipment servicing the building<br>(Describe type of equipment in Comments) | <u>286.0</u>  | <input checked="" type="checkbox"/> feet | <input type="checkbox"/> meters (Puerto Rico only) |
| f) Lowest adjacent (finished) grade (LAG)  | <u>282.5</u>  | <input checked="" type="checkbox"/> feet | <input type="checkbox"/> meters (Puerto Rico only) |
| g) Highest adjacent (finished) grade (HAG)   | <u>286.0</u>  | <input checked="" type="checkbox"/> feet | <input type="checkbox"/> meters (Puerto Rico only) |

In this example, the BFE is 285.

The slab-on-grade house was elevated on fill 1' above the BFE, and the vented garage is 2.5' below the BFE.

You will get a blank Elevation Certificate form when you get your permit. You must have a licensed surveyor or engineer fill it out and seal it. The Elevation Certificate includes diagrams for eight building types. Several points must be surveyed.

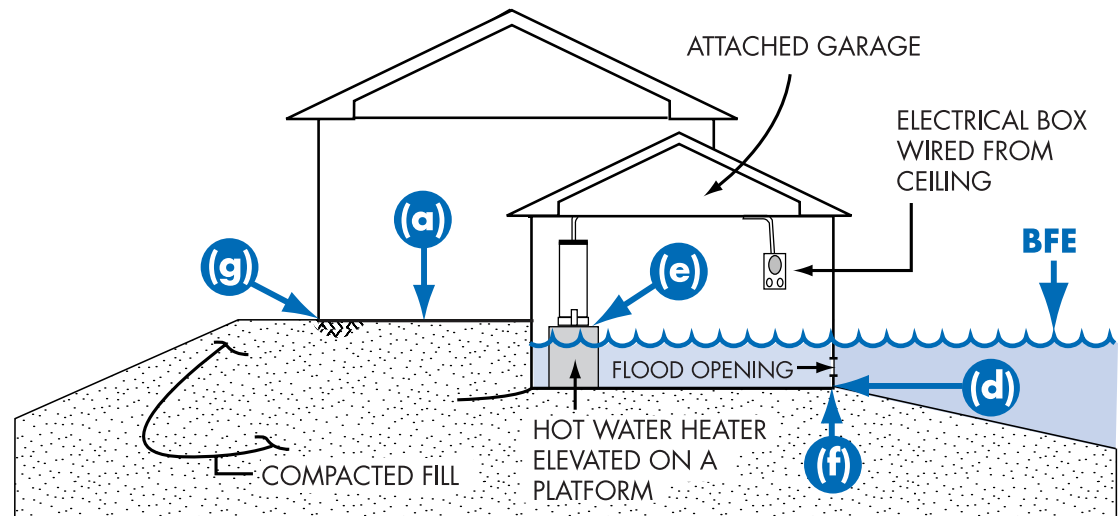

## Paperwork is Important – for You and Your Community

### Terms and Definitions

**Lowest Floor** means the lowest floor of the lowest enclosed area (including basement). An unfinished or flood resistant enclosure (that is not a basement) is not the lowest floor if the enclosure is built as required in the local ordinance (see page 41), and is used for parking, access and limited storage.

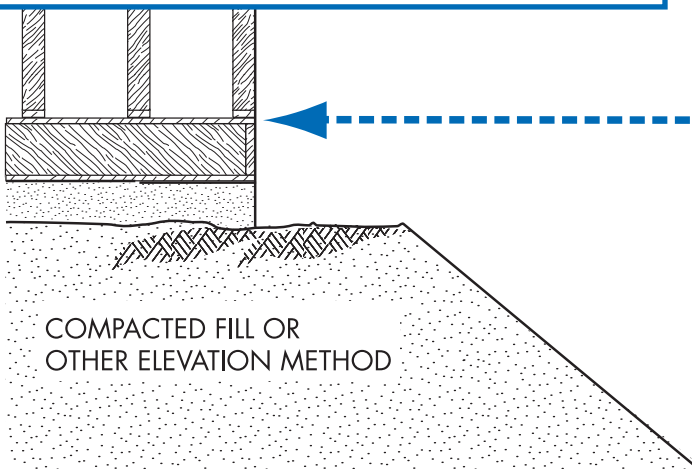

If you get a permit to build in the floodplain, you will be given an Elevation Certificate form. As soon as your lowest floor is set, get the form filled out and sealed by a licensed surveyor or engineer. This form is important. It proves that you built correctly, and it can be used to get the lowest cost flood insurance.

## Floodplain Fill Can Make Things Worse

Floodplains are supposed to store floodwater. If storage space is filled with dirt and other material, future flooding may be worsened. Your community may require an engineering analysis (“no rise” certificate) to show how floodplain fill will alter flooding. Floodplain fill can alter other valuable floodplain functions, including wildlife habitat and wetlands.

**Make sure your floodplain fill project won’t harm your neighbors. Floodway fill is allowed only if an engineering evaluation demonstrates that “no-rise” in flood level will occur (see page 36).**

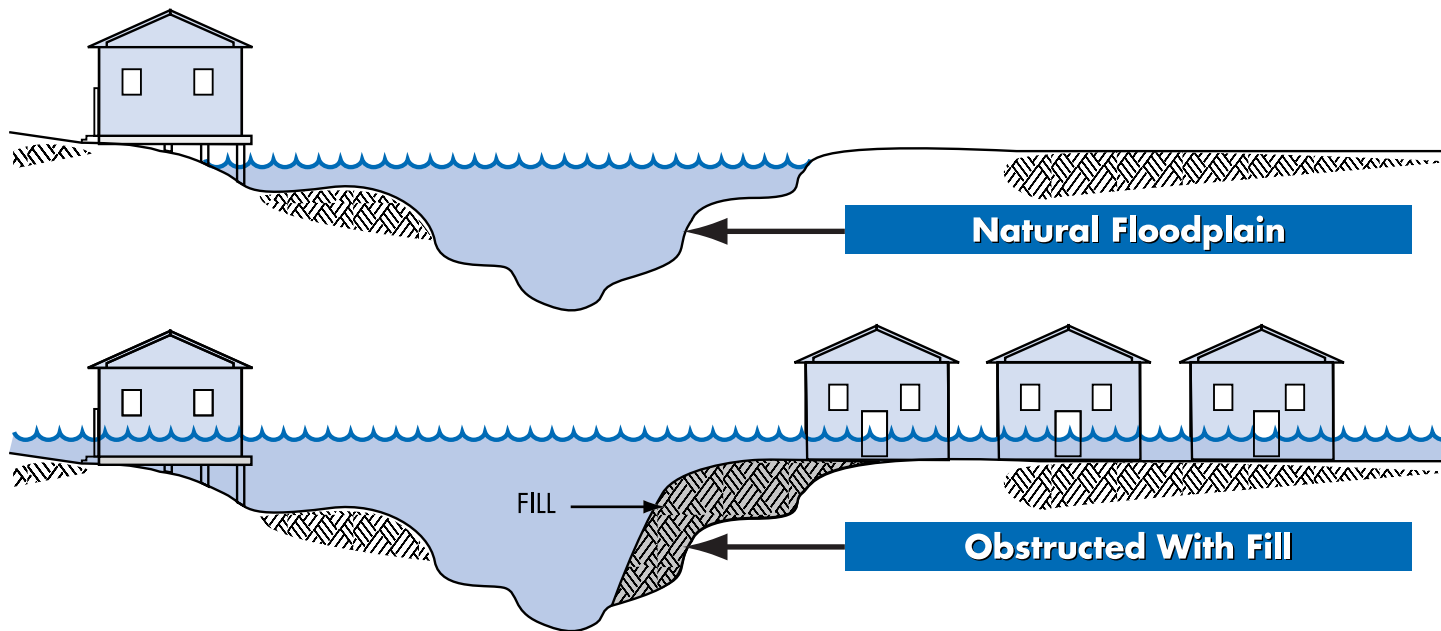

## Recommended Floodway “No Rise” Certification

- Floodways can be dangerous because water may flow very fast
- Development is not allowed unless “no rise” in flood levels, floodway elevations and floodway widths is certified
- An engineer must evaluate the hydraulic impact of proposed development
- A “no rise” certification is required and must be signed, sealed, and dated by a registered professional engineer
- Check with your community for guidance **before** you decide to work in a floodway

### ENGINEERING “NO-RISE” CERTIFICATION *(example)*



This is to certify that I am a duly qualified engineer licensed to practice in the State of Texas. It is to further certify that the attached technical data supports the fact that proposed **(Name of Development)** will not impact the Base Flood Elevations (100-year flood), floodway elevations and the floodway widths on **(Name of Stream)** in **(Name of Community)**.

Signature \_\_\_\_\_ Seal \_\_\_\_\_

**The engineering analysis must be based on technical data approved from FEMA. Save time and money – don’t build in the floodway.**



# How to Elevate Your Floodplain Building (Riverine)

## Elevate on Foundation Walls

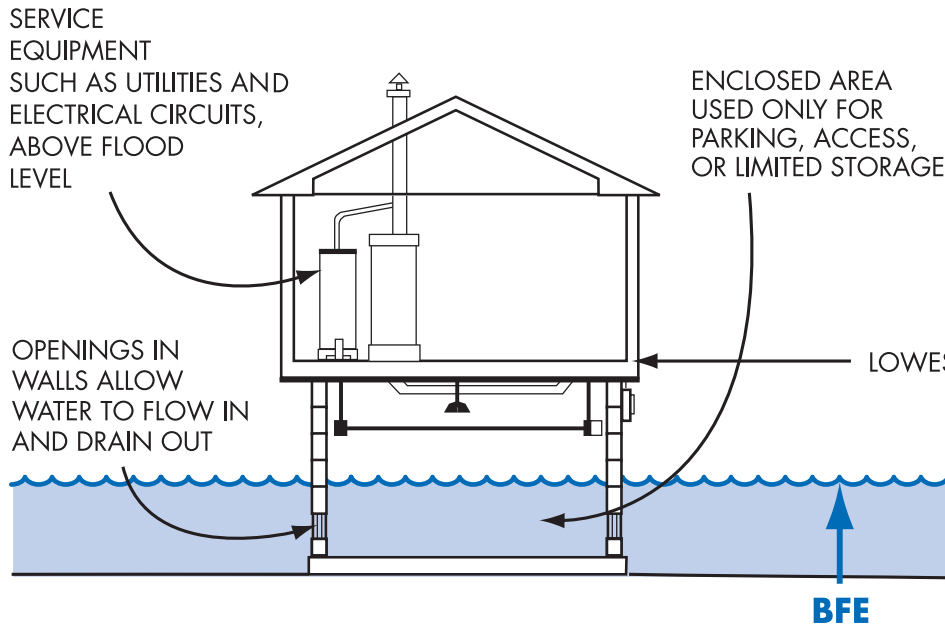

## Elevate on Fill

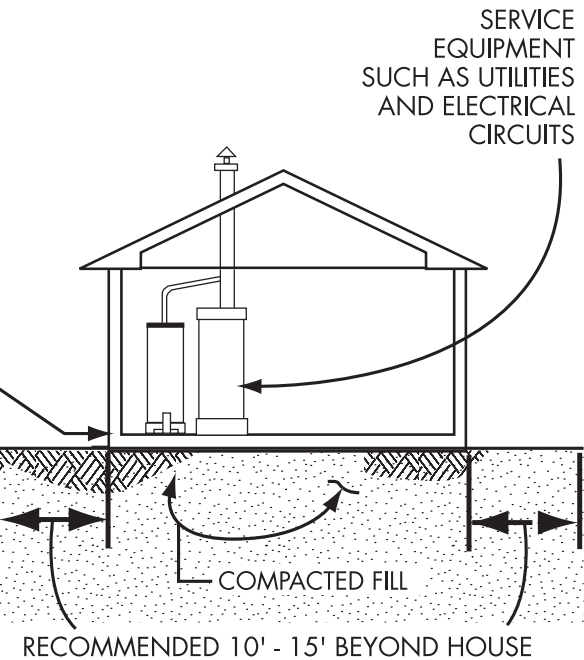

**Caution:** Enclosures (including crawlspaces) have some special requirements, see page 41. Note: When the walking surface of the lowest floor is at the minimum elevation, under-floor utilities are not allowed. Fill used to elevate buildings must be placed properly (see page 38).

## Compaction of Floodplain Fill (A Zone)

Earthen fill used to raise the ground above the flood elevation must be placed properly so that it does not erode or slump when water rises. For safety and to meet floodplain requirements, floodplain fill should:

- Be good clean soil, free of large rocks, construction debris, and woody material (stumps, roots)
- Be machine compacted to 95 percent of the maximum density (determined by design professional)
- Have graded side slopes that are not steeper than 2:1 (one foot vertical rise for every 2 feet horizontal extent); flatter slopes are recommended.
- Have slopes protected against erosion (vegetation for “low” velocities, durable materials for “high” velocities – determined by design professional)

Note: Fill **may not** be used to elevate a building in V Zones. Information on elevating in V Zones on pages 42 through 45.

**Your community may ask for certification of the elevation, compaction, slope, and slope protection materials. Your engineer or design professional can find more information in FEMA’s technical guidance (MT-1).**

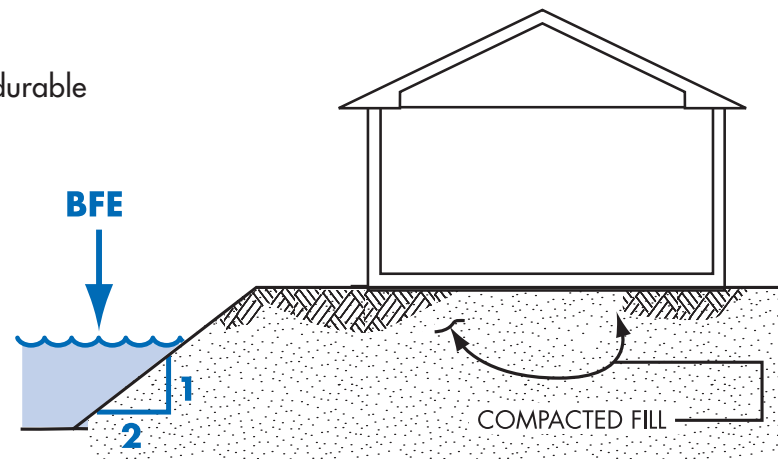

## Basements Are Unsafe

Basements below the BFE **are not** allowed in new development and flood insurance coverage is very limited in existing basements for a very good reason. It only takes an inch of water over the sill and the entire basement fills up. Excavating a basement into fill doesn't always make it safe because saturated groundwater can damage the walls.

**de** **Terms and Definitions**

A **basement** is any portion of a building that has its floor sub-grade (below ground level) on all sides.

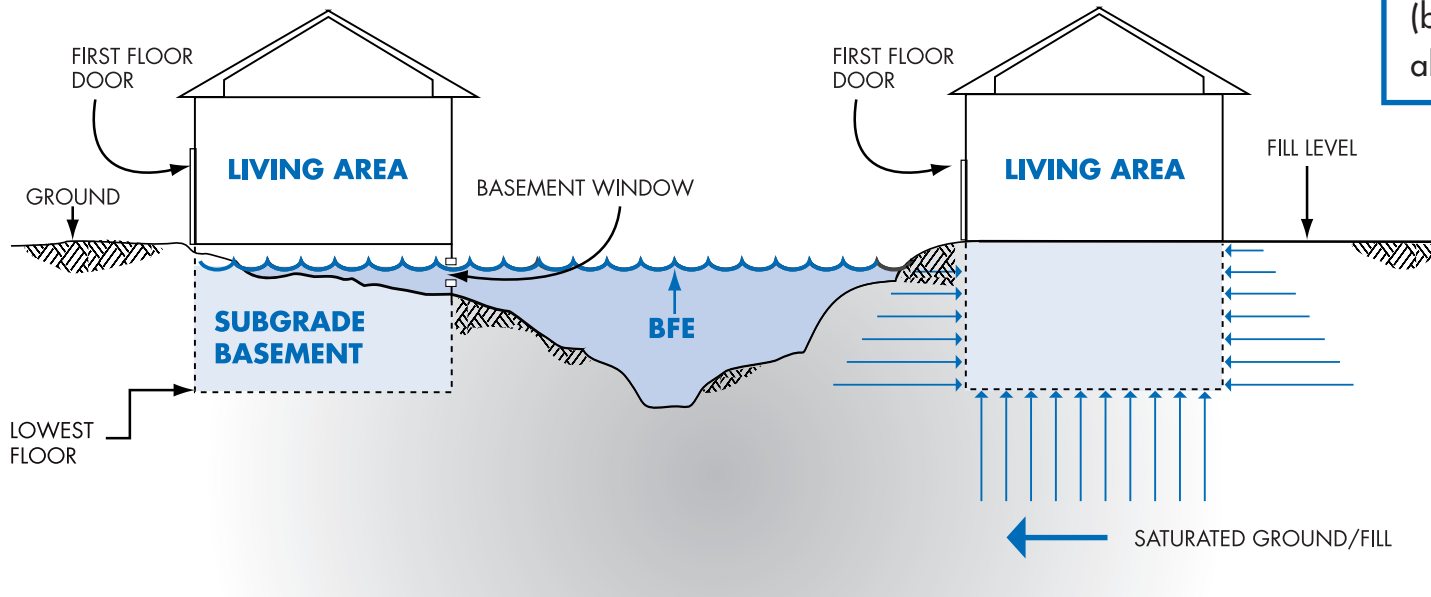

## Manufactured Homes Deserve Special Attention

Experience shows that manufactured homes are easily damaged. As little as one foot of water can cause substantial damage.

Dry stacked blocks are **NOT** acceptable — they will **NOT** withstand a flood.

**Manufactured homes must be anchored to resist flotation, collapse, or lateral movement by being tied down in accordance with your community's ordinance or the manufacturers' installation specifications.**

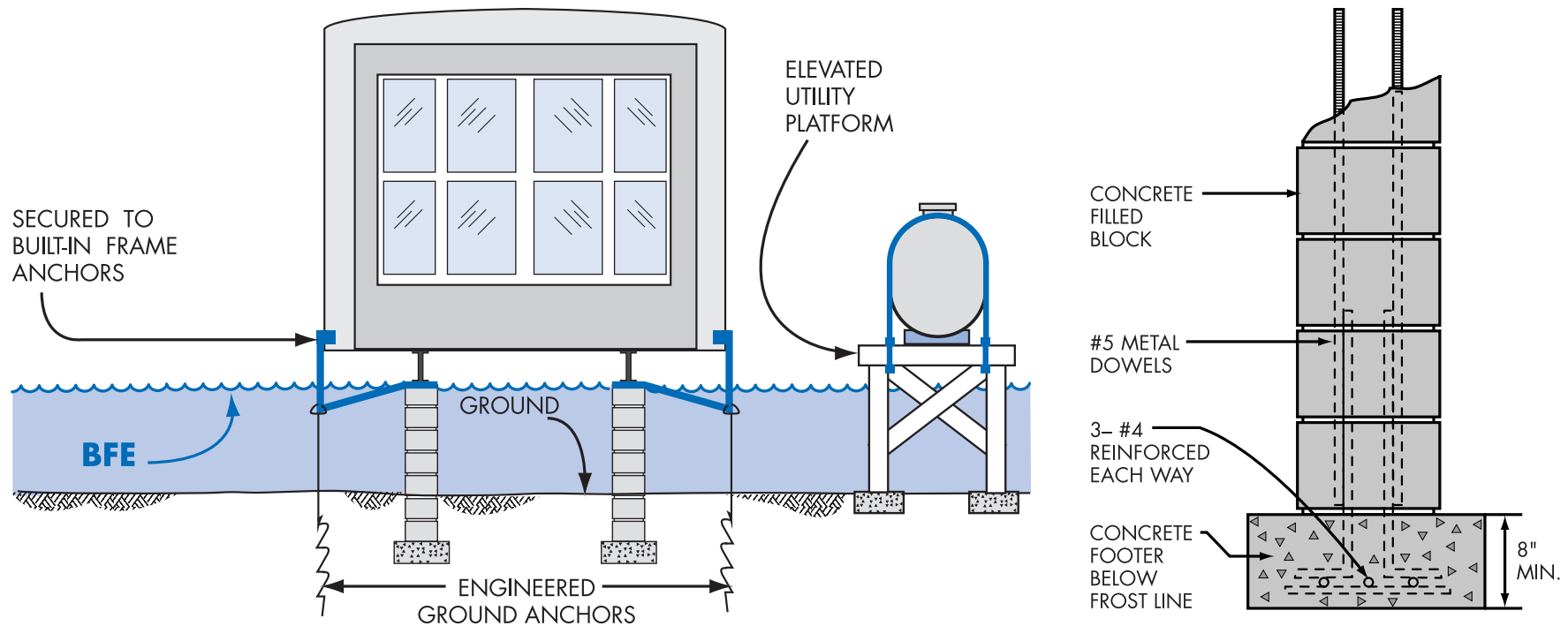

## Enclosures Below the BFE (Riverine Only)

Solid perimeter wall foundations can enclose flood-prone space. A crawlspace is a good way to elevate just a couple of feet. In all cases, the following are required: openings/vents, elevated utilities, flood resistant materials, and limitations on use.

### NOTE:

- TOTAL NET AREA OF ALL TOTAL OPENINGS IS 1 SQ. IN. PER SQ. FT. OF ENCLOSED AREA
- A 25' X 45' BUILDING NEEDS 1125 SQ. INCHES OF OPENINGS (25 X 45 = 1125)
- STANDARD VENTILATION UNITS USED IN BLOCK FOUNDATION WALLS MUST BE DISABLED IN THE OPEN POSITION TO ALLOW WATER TO FLOW IN AND OUT
- A STANDARD VENTILATION UNIT, WITH SCREEN, PROVIDES 42 TO 65 SQ. INCHES OF OPENING
- ENGINEERED OPENINGS ARE ACCEPTABLE IF CERTIFIED TO ALLOW ADEQUATE AUTOMATIC INFLOW AND OUTFLOW OF WATER

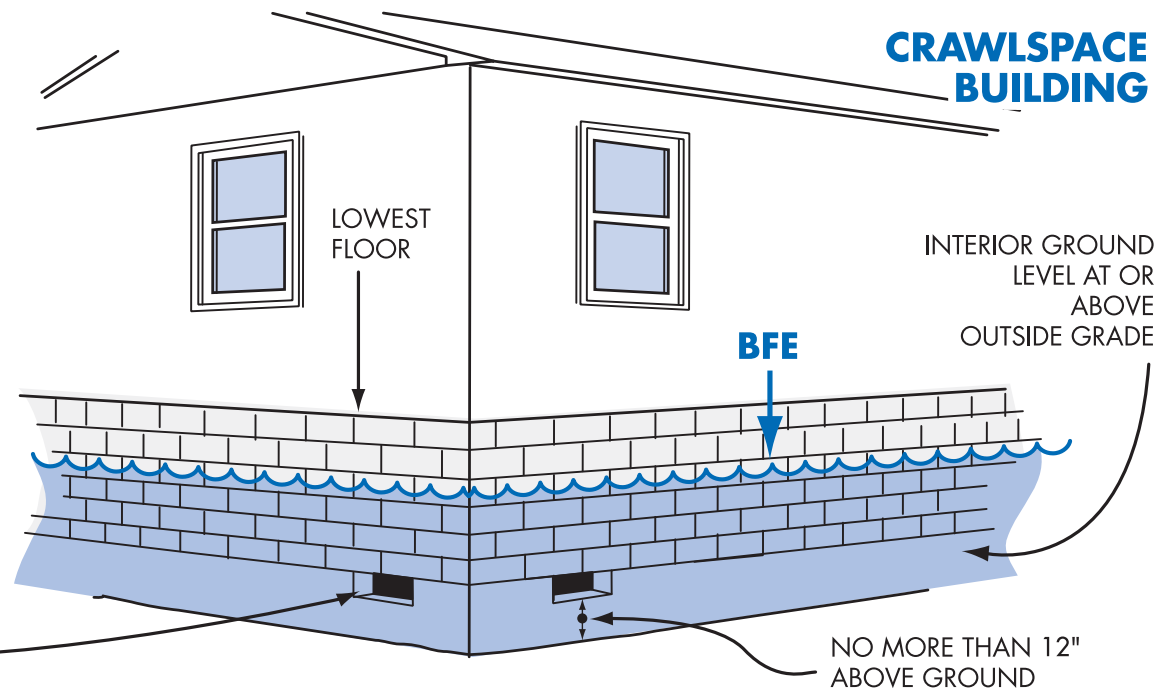

## Typical Elevation Methods for Coastal Buildings

In V Zones the design specifics will be determined by your licensed architect or engineer based on your site, including how your building will be elevated and how deep in the ground the foundation elements will extend. Your community will require certified or sealed building designs and plans (see page 45).

### Elevate on Pilings

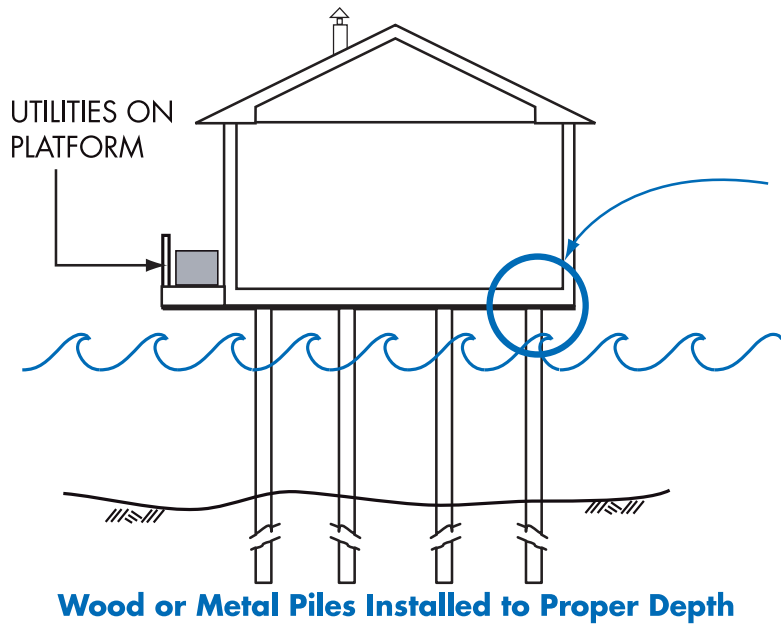

See details on  
page 43

**BFE**

### Elevate on Columns

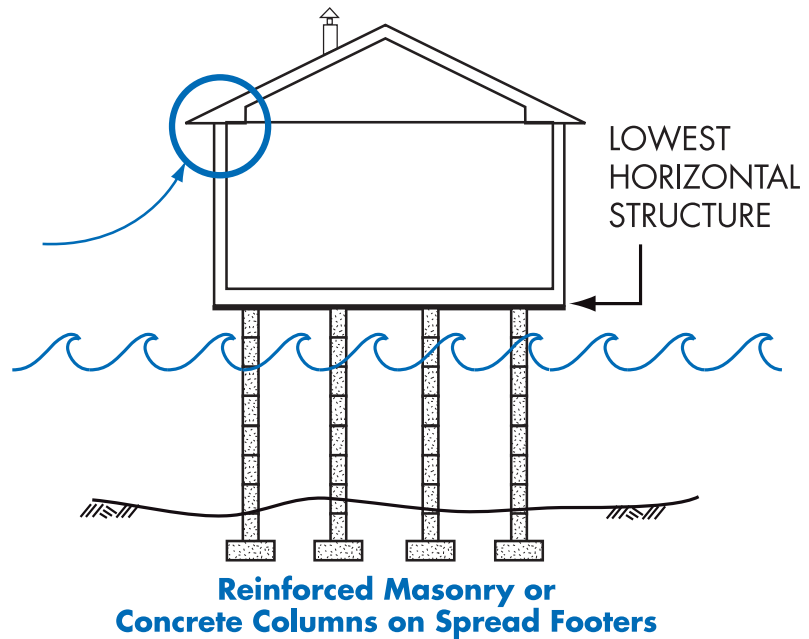

## Coastal Houses Must Resist Wind and Water Forces

Coastal buildings may be exposed to both hurricane winds and floodwater, so they must be built to hold together during storms. These details are only examples. Your architect or engineer will decide the type of clips and straps to keep the roof and building connected to the foundation.

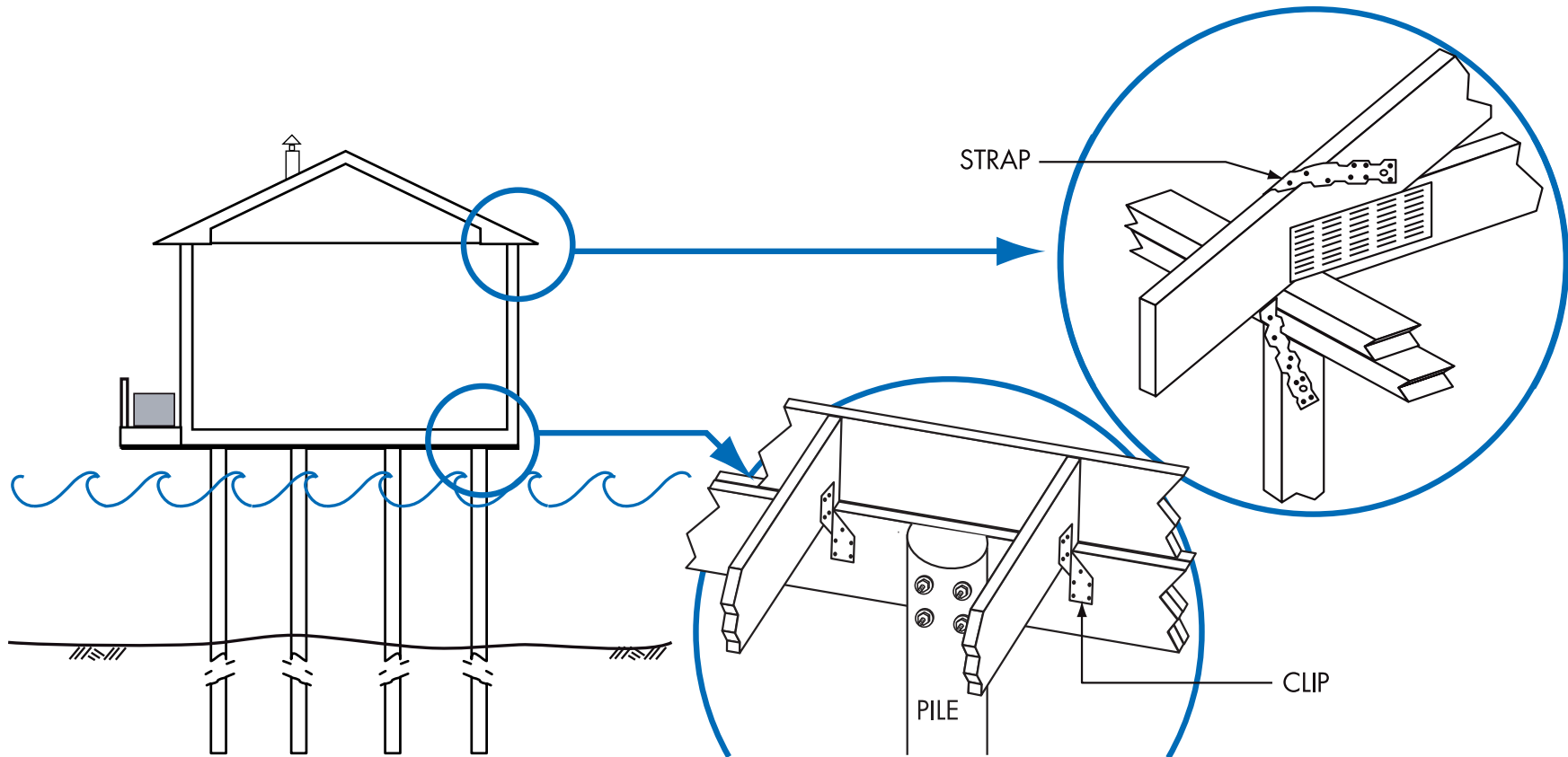

## Enclosures Below V Zone Buildings

Avoid building an enclosure under your V Zone building. If you must enclose a small area, your community will require:

- Walls designed to collapse or “breakaway” under storm and flood conditions
- Flood resistant materials
- Utility wires and pipes should not go through or be attached to the breakaway walls
- Enclosed area is to be used only for parking, building access, or storage
- No bathrooms, utility rooms, or electric service below BFE
- Size limited to 300 square feet or less



### Information

Do not modify an enclosure below an elevated V Zone building (or any zone for that matter). It is a violation of your community's regulations, and you may have increased damage when it floods. Plus, your flood insurance policy will cost a lot more.

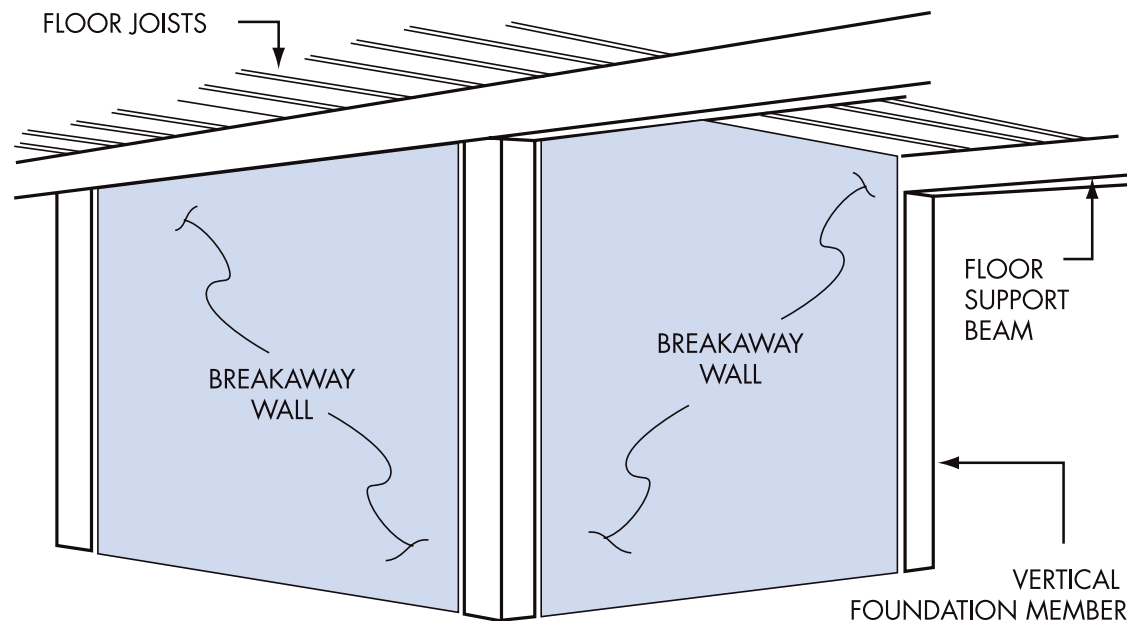



# The V Zone Certificate (Sample)

**V Zone Building Design and Performance Certificate** *(partial)*

**Section 2: Elevation Information**

1. Elevation of the Bottom of the Lowest Horizontal Structural Member..... 17 feet
2. Base Flood Elevation (BFE)..... 16 feet
3. Elevation of Lowest Adjacent Grade (LAG)..... 6 feet
4. Foundation type: Piling  Post \_\_\_/ Pier \_\_\_/ Column \_\_\_/ Fill \_\_\_/ Shear Wall \_\_\_/ Enclosed Wall \_\_\_/  
 Foundation Description: Driven Wood piles. No Obstructions except open stairs
5. Approximate depth of scour/erosion used for foundation design..... 3 feet
6. Embedment depth of pilings or foundation below LAG..... 16 feet

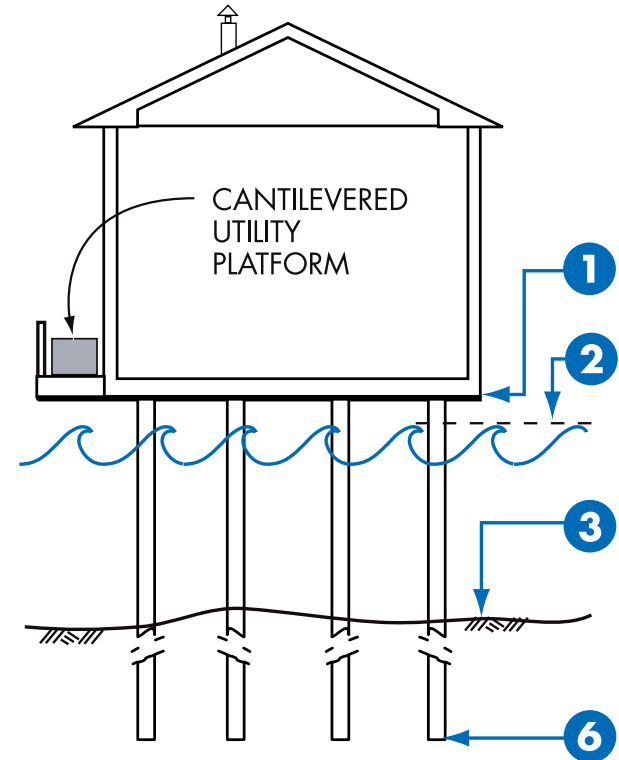

A Registered Professional Engineer or Architect must review or prepare your building design and provide a signed and sealed statement that the design meets minimum design and construction requirements. You will also need to submit an "as built" Elevation Certificate when construction is finished.

Resource: *Coastal Construction Manual (FEMA 55CD)*. Revised in 2000, this interactive CD is a useful tool for engineers and architects who design buildings in V zones.

## Utility Service Outside Buildings

**Heat Pump or A/C  
on Platform**

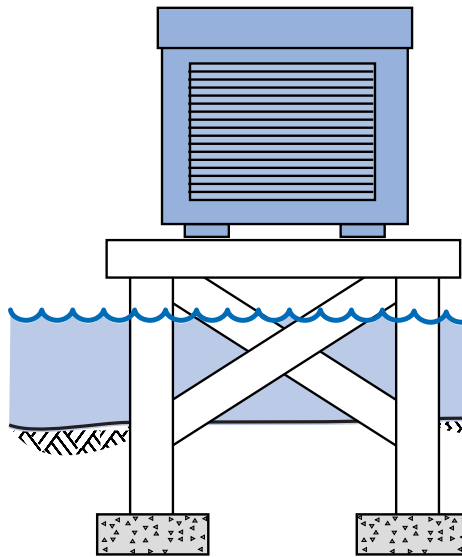

**Fuel or Propane Tank  
Anchored on Platform**

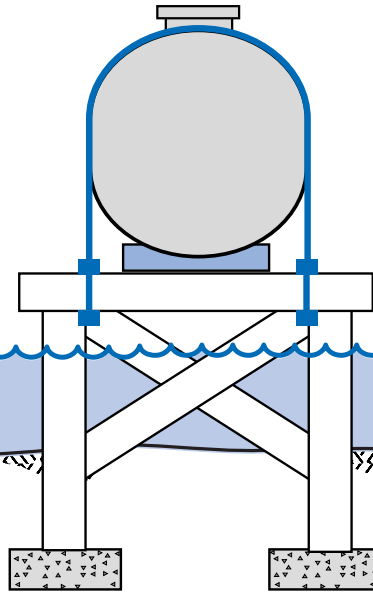

**BFE**

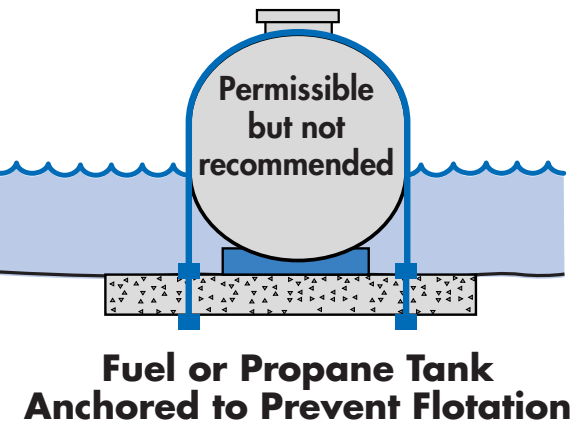

Whether inside an attached garage or outside the building, all utilities, appliances and equipment must be elevated above the BFE or protected against flood damage. Utilities include plumbing, electrical, gas lines, fuel tanks, and heating and air conditioning equipment.



**Important**

### **Information**

Fuel and propane tanks may cause explosion and pollution risks during flood conditions. Even shallow water can create large buoyant force on tanks, so extra care must be taken to ensure that all tanks are anchored.

## Utility Service Inside Enclosures

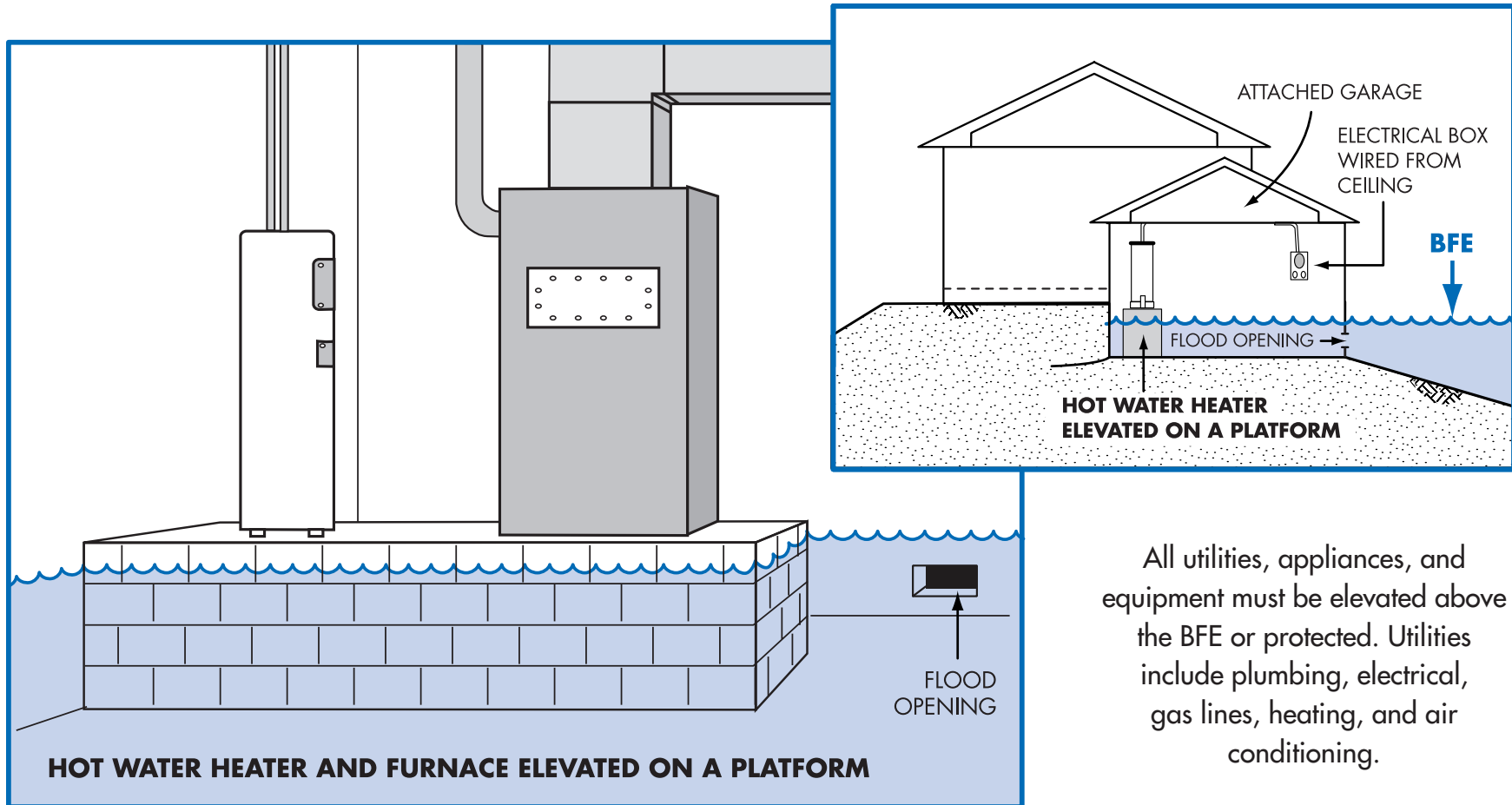

## Accessory (Appurtenant) Structures

- Not habitable
- Anchored to resist floating
- Flood openings/vents
- Built of flood resistant materials
- Elevated utilities
- Used only for storage or parking
- Cannot be modified for different use in the future
- Documented floor elevation

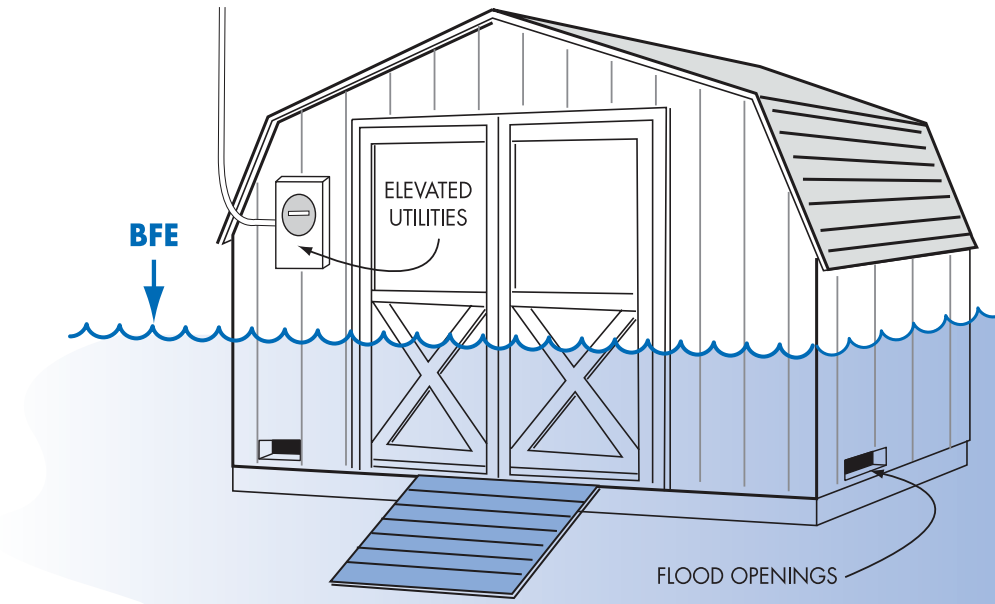

Even small buildings are “development” and permits are required. They must be elevated or anchored and built to withstand flood damage. Caution: Remember, everything inside is likely to get wet when flooding occurs.

### Terms and Definitions

**Accessory (Appurtenant) Structure** means a structure that is located on the same parcel of land as a principal structure and whose use is incidental to the use of the principal structure. Accessory structures should be no more than a minimal initial investment, may not be used for human habitation, and must be designed to minimize flood damage. Examples: detached garages, carports, storage sheds, pole barns, and hay sheds.

## Recreational Vehicles

In a flood hazard area, an RV must:

- Be licensed and titled as an RV or park model (not as a permanent residence)
- Be built on a single chassis
- Have inflated tires and be self-propelled or towable by light truck
- Have no attached deck, porch, shed
- Be used for temporary recreational, camping, travel, or seasonal use (no more than 180 days)
- Be less than 400 sq. ft. in area (measured at largest horizontal projection)
- Have quick-disconnect sewage, water, and electrical connectors

**RVs that do not meet these conditions must be installed and elevated like Manufactured Homes, including permanent foundations and tie-downs (see page 40).**



**Important**

### Information

Camping near the water? Ask the campground or RV park operator about flood warnings and plans for safe evacuations.

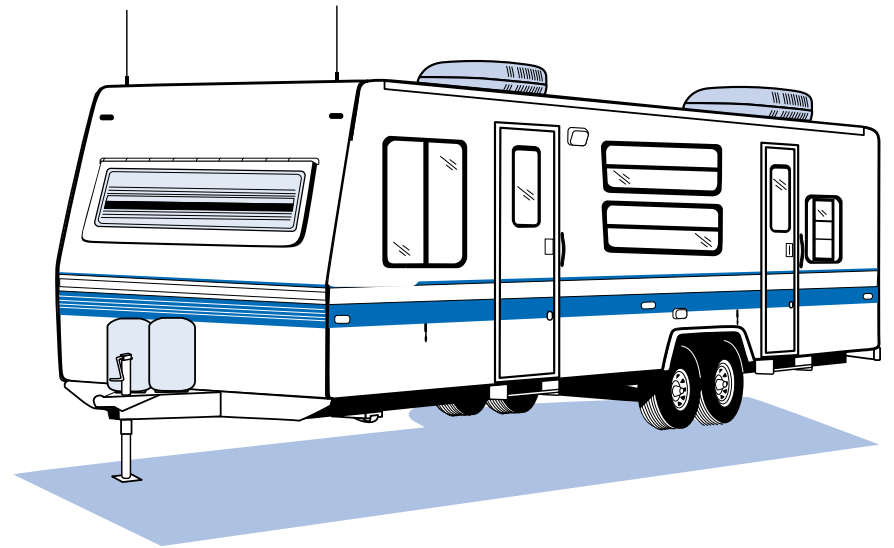

## Planning to Improve Your Floodplain Building?

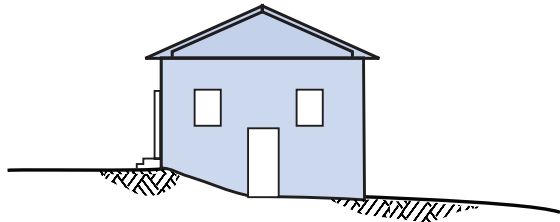

**Before Improvements**  
**Building Market Value = \$110,000**

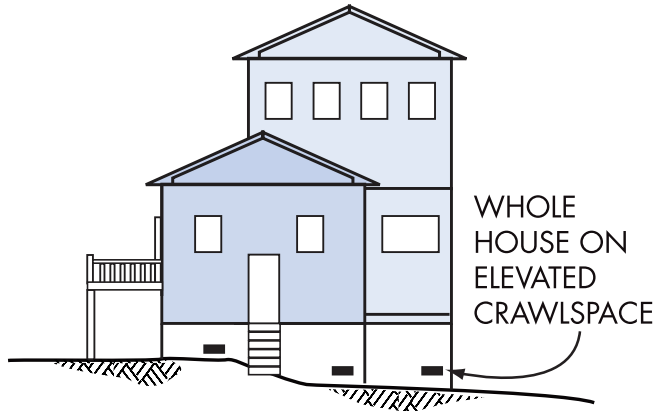

**After Improvements**  
**Cost of Improvements = \$68,500**



### Important

#### Information

If the cost of the improvement equals or exceeds 50% of the market value of the building, you must comply with the Substantial Improvement requirements.

If the costs are less than 50% of its market value, only the addition is required to be built above the BFE, but you should still consider ways to reduce future damage.

The cost to correct previously cited violations of state or local health, sanitary, or safety code to provide safe living conditions can be excluded.

Alteration of a registered historic structure is allowed, as long as it will continue to meet the criteria for listing as a historic structure.



### Terms and Definitions

Substantial improvement means any reconstruction, rehabilitation, addition, or other improvement of a structure, the cost of which equals or exceeds 50 percent of the market value of the structure before the start of construction of the improvement. This term includes structures which have incurred substantial damage from any cause, regardless of the actual repair work performed (see page 51).

## What About After Damages?

A permit is required to repair substantial damage from any cause — fire, flood, wind, or even a truck running into a building. Check with your community permit office to be sure. You will be asked to provide a detailed cost estimate for repairs. See page 52 for more information about elevating an existing building on a crawlspace.

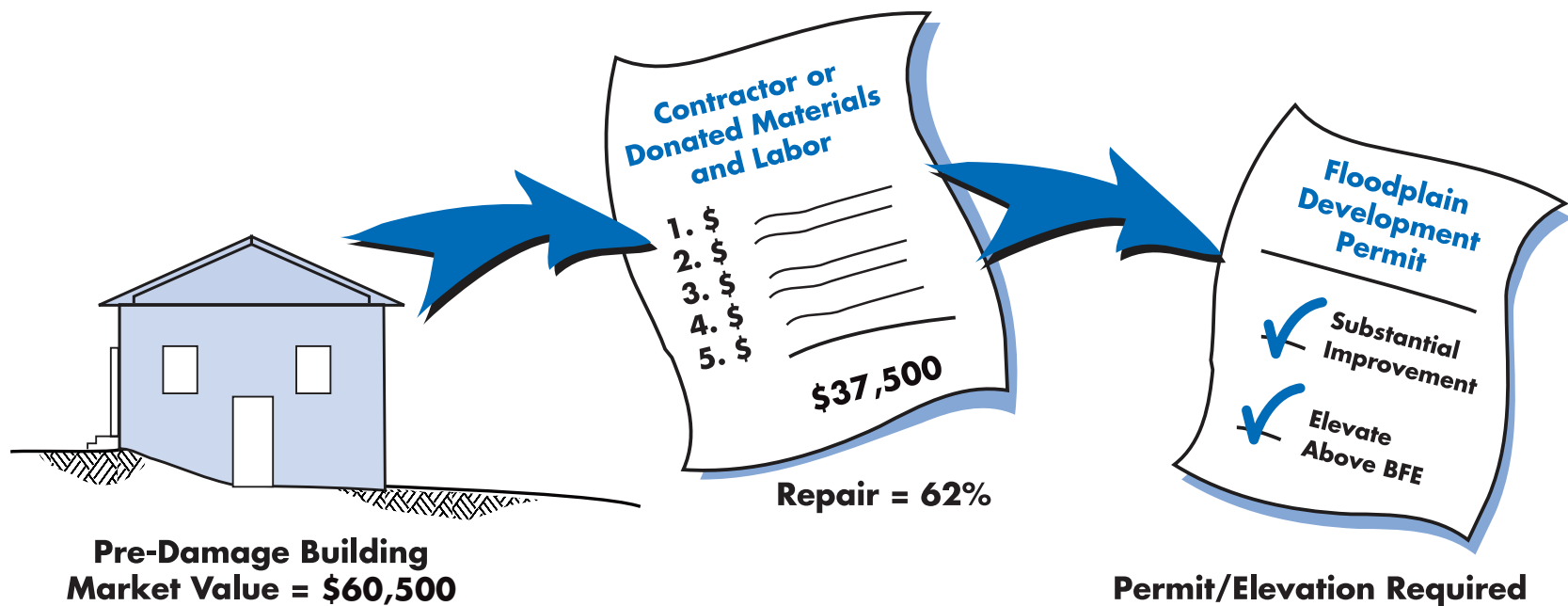

## Elevating a Pre-FIRM Building

This is one way to elevate an existing building to comply with floodplain regulations. If your insured building is damaged by flood, you may be eligible for an Increased Cost of Construction payment. The state and FEMA can help with more information and options.

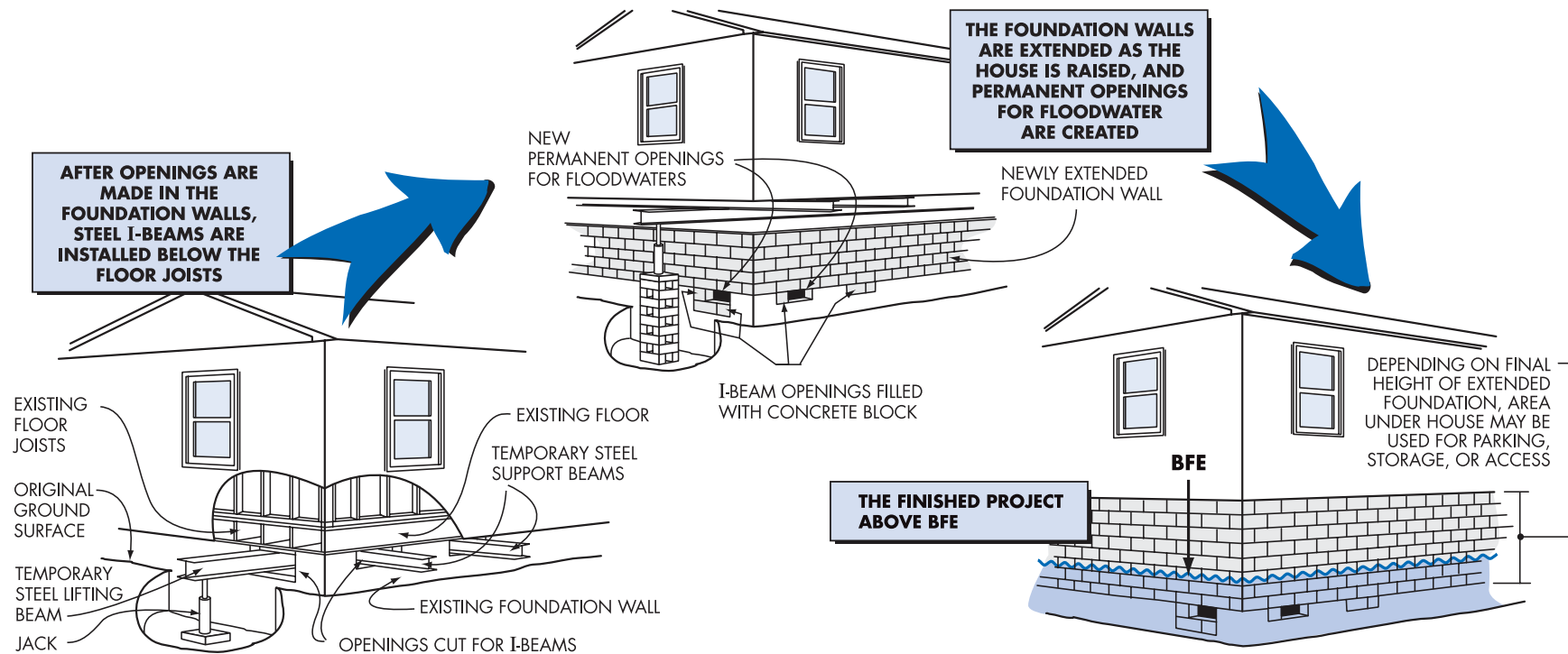



## Some Flood Protection for Older Homes is Easy and Low Cost

Move your hot water heater, furnace and ductwork out of basements and crawlspaces or build small platforms for them above the BFE. Anchor heating oil and propane tanks to prevent flotation. Do not store valuables or hazardous material in a flood-prone basement or crawlspace. Use water-resistant materials when you repair.

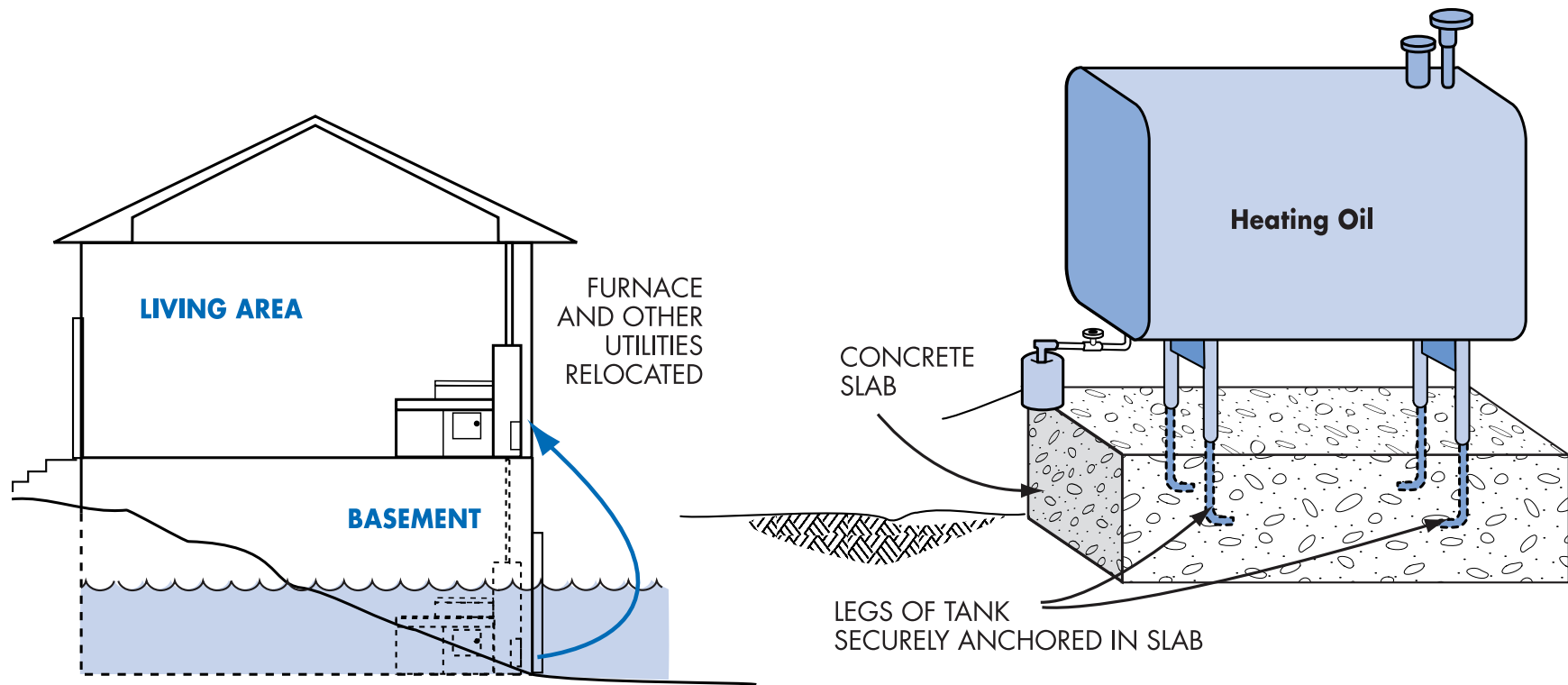

## Small Levees and Floodwalls Can Protect Some Older Homes

In areas where floodwaters aren't expected to be deep, sometimes individual buildings can be protected by earthen levees or concrete floodwalls. You must get a permit for those protection measures, and extra care must be taken if the site is in a floodway. A levee or floodwall cannot be used to comply with floodplain regulations for a new or substantially improved building, or one that is repaired after substantial damage. Important: These protective measures will not reduce your flood insurance premium.

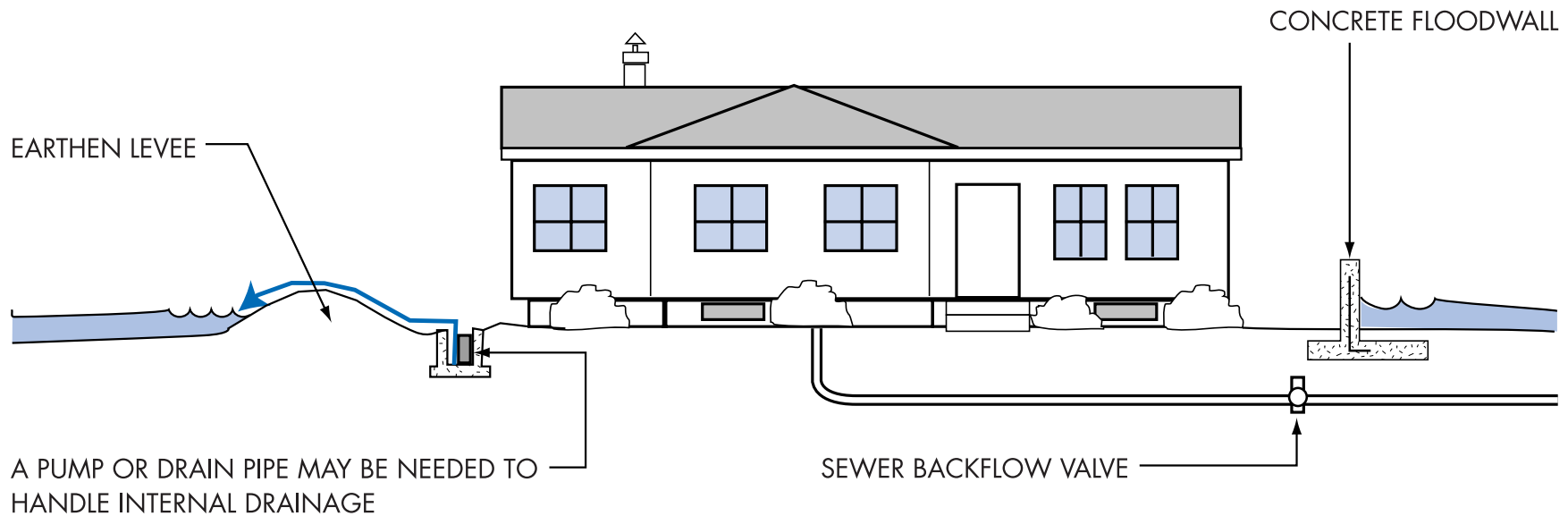

## Some Flood Mitigation Projects are More Costly ut Give You More Protection

After floods, some communities buy out and demolish homes that were severely damaged. The acquired land is dedicated to open space and can be used for recreation or to help restore wildlife habitat and wetlands. In other instances, homes have been raised up on higher foundations, and others have been moved to safer high ground.

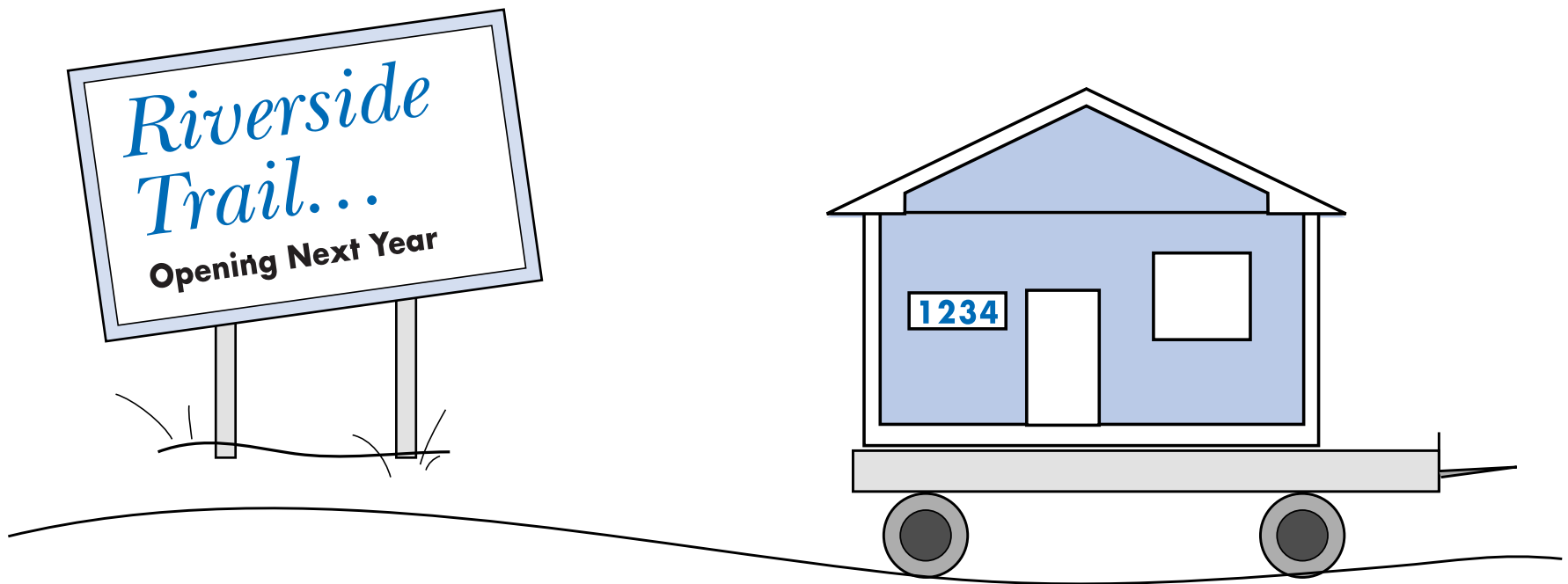

## Be Flood Safe — Don't Drive Through Flooded Roads

- Never drive through flooded roads – they may be washed out.
- Passenger cars may float in only 18-24 inches of water.
- Floating cars easily get swept downstream, making rescues difficult and dangerous.
- Be especially cautious at night when it is harder to recognize dangers.
- Hundreds of people have died in floods in Texas – many were trapped in cars.
- It takes only six inches of fast moving water to sweep you off your feet.

**Flash floods are dangerous. Do not try to walk or drive through fast-moving water.**



## Useful Web Sites and Common Acronyms

### Useful Web Sites

- American Red Cross: <http://www.redcross.org/services/disaster>
- FEMA Resource Library: <http://www.fema.gov/library/>
- FEMA NFIP information: <http://www.fema.gov>
- FEMA Map Service Center: <http://msc.fema.gov>
- Community Rating System (CRS) Resource Center: <http://www.training.fema.gov/EMLweb/CRS>
- Association of State Floodplain Managers: <http://www.floods.org>
- Texas Floodplain Management Association: <http://www.tfma.org>
- Texas Water Development Board: <http://twdb.state.tx.us>
- Texas Department of Insurance: <http://tdi.state.tx.us>
- Texas General Land Office: <http://www.glo.state.tx.us>
- Texas Division of Emergency Management: <http://dps.state.tx.us/dem>
- Texas Hazard Mitigation Package: <http://www.thmp.info/>

### Common Acronyms

- BFE = Base Flood Elevation
- EC = Elevation Certificate
- FEMA = Federal Emergency Management Agency
- FIRM = Flood Insurance Rate Map
- NFIP = National Flood Insurance Program
- SFHA = Special Flood Hazard Area
- TWDB = Texas Water Development Board
- TFMA = Texas Floodplain Management Association

### Federal Agency Resources

#### Federal Emergency Management Agency (FEMA)

Is the originating Agency for NFIP & Map Modernization Program. Provides for studies to update Flood Insurance Rate Maps. Prepares updated digitized FIRMs and publishes "Preliminary" D-FIRMs.

[www.fema.gov](http://www.fema.gov) for general information

[www.msc.fema.gov](http://www.msc.fema.gov) for the Map Service Center

#### U.S. Army Corps of Engineers

Conducts flood studies. Oversees capital projects in waterways. Determines flood damage assessments for property buyouts. Issues 404 Wetlands Permits.

[www.usace.army.mil](http://www.usace.army.mil)

#### National Weather Service

Provides weather forecasts and severe weather alerts through the internet, television, and NOAA All Hazard Radio. Regional River Forecast Office provides flood forecasts. Promotes Severe Weather and Turn Around Don't Drown awareness.

[www.weather.gov](http://www.weather.gov)

#### U.S. Fish and Wildlife

May be required to involve in certain projects to issue a permit.

[www.fws.gov](http://www.fws.gov)

#### National Park Service

May be required to involve in certain projects to issue a permit.

[www.nps.gov](http://www.nps.gov)

#### Association of State Floodplain Managers (ASFPM)

Provides technical information for Nation Wide floodplain management challenges, legislation, and support.

[www.floods.org](http://www.floods.org)

## Resources

### Environmental Protection Agency (EPA)

Provides guidance on Clean Water Act and may need to be contacted for certain permits to be issued.

[www.epa.gov](http://www.epa.gov)

### National Resource Conservation Service (NRCS)

May be required to involve in certain projects to issue a permit and may have technical information relevant to floodplain management.

[www.nrcs.usda.gov](http://www.nrcs.usda.gov)

### National Highway Administration

May be required to involve in certain projects to issue a permit.

[www.nhtsa.dot.gov](http://www.nhtsa.dot.gov)

## State Agency Resources

### Texas Water Development Board (TWDB)

State National Flood Insurance Program (NFIP) Coordinating Agency. Partners with FEMA – Community Assistance Program. Provides technical assistance, training, ordinance/court order assistance, and public outreach. Part of the Agency entails the Texas Natural Resources Information System (TNRIS) which is the State mapping and geographic information data repository. State Map Modernization Coordinator. Manages Flood Mitigation Assistance Grant Program, Flood Protection Planning Grant fund, and the Severe Repetitive Loss Grant fund.

Mike Howard is the NFIP State Coordinator; his phone number is (512) 463-3509. The Board also has 6 Regional Offices that are staffed with NFIP knowledgeable staff:

Austin (512) 463-4350

El Paso (915) 834-5626

Harlingen (956) 421-3214

Houston (281) 895-6555

Mesquite (972) 285-8078

San Antonio (210) 212-9324

[www.twdb.state.tx.us](http://www.twdb.state.tx.us)

[www.twdb.state.tx.us/planning/flood/fmp.asp#nfip](http://www.twdb.state.tx.us/planning/flood/fmp.asp#nfip) for community floodplain administrators and community status list.

## Resources

### **Governor's Division of Emergency Management**

State Coordinator for Emergency Management in Texas. Provides for State and Federal disaster preparedness, response, recovery, and mitigation. Is the State Hazard Mitigation Officer (SHMO). Administers the Federal Hazard Mitigation Grant Program (HMGP) and Pre-Disaster Mitigation (PDM) grant program.

[www.txdps.state.tx.us/dem](http://www.txdps.state.tx.us/dem)

### **Texas Department of Insurance**

Named as co-coordinator for the NFIP in Texas (TWDB is the other State agency). Provides aid, advises and cooperates with all participating political subdivisions. Administers Windstorm Inspection Program (first tier of Texas counties fronting Gulf of Mexico). Facilitates availability of wind insurance.

[www.tdi.state.tx.us](http://www.tdi.state.tx.us)

### **Texas Commission on Environmental Quality (TCEQ)**

Oversees State Dam Safety Program, which monitors and regulated both private and public dams in Texas

[www.tceq.state.tx.us](http://www.tceq.state.tx.us)

### **Texas Office of Rural Community Affairs**

Manages community development grants including the Community Development Block Grant and the Disaster Relief & Urgent Need fund for communities after a disaster

[www.orca.state.tx.us](http://www.orca.state.tx.us)

### **Texas General Land Office (GLO)**

Texas Coastal Management Program (CMP) is to improve the management of the State's coastal natural resources and to ensure the long-term ecological and economic productivity of the coast. Oversees Open Beaches Act, which provides that all beaches be public land and open for public access. Manages Dune Protection Program, which protects sand dunes for coastal stabilization, storm protection, ecosystem management, and economic development.

[www.glo.state.tx.us](http://www.glo.state.tx.us)



## Resources

### **Texas Department of Housing and Community Affairs (TDHCA)**

Have anchoring regulations listed for manufactured homes and other important information regarding installation of manufactured homes.

[www.tdhca.state.tx.us](http://www.tdhca.state.tx.us)

### **Texas Department of Health**

Handles individual grants for families after a disaster.

[www.dshs.state.tx.us](http://www.dshs.state.tx.us)

### **Texas Parks and Wildlife**

Handles permits for sand and gravel operations and addresses environmental concerns.

[www.tpwd.state.tx.us](http://www.tpwd.state.tx.us)

## **National Legislation/Regulation**

### **National Flood Insurance Act of 1968**

Established National Flood Insurance Program; a voluntary program based on mutual agreement between Federal government and local community. In exchange for adopting and enforcing a Floodplain Management Ordinance or Court Order, federally backed flood insurance is made available to property owners throughout the participating community. Prior to the 1968 Act the sole relief available to flood victims was special disaster loans. See 44 Code of Federal Regulations (CFR) Chapter 60.3 (a-e) for detailed floodplain management regulations.

### **Flood Disaster Protection Act of 1973**

Now required flood insurance as a condition for Receiving federal financial assistance for acquisition or construction purposes in Special Flood Hazard areas. Publication of Flood Hazard Boundary Maps now officially designated a community as “flood prone” and subject to the act.

### **Executive Order 11988**

Specified responsibility for Federal government to adhere to the NFIP regulations like local communities. Federal Agencies are now required to “avoid long-and short-term adverse impacts associated with the occupancy and modification of floodplains and avoid direct and indirect support of floodplain development wherever there is a practicable alternative”. Federally funded “Critical Facilities” like Hospital and Fire Stations are to be protected to the 0.2% Annual Chance Event or 500 year flood.

### **Section 404 Wetlands Permits**

The US Army Corps of Engineers administers Section 404 of the Clean Water Act. Discharge of dredge or fill material into wetlands requires a Section 404 permit. Communities are required under the NFIP to require completion of all necessary permits required by Federal and State Law prior to issuing floodplain development permit.

### **Disaster Mitigation Act of 2000**

Communities must adopt and have an approved all hazards mitigation plan prior to November 1, 2004 to be eligible to receive Hazard Mitigation Grant Program funding (44 CFR Part 201).

## **State Legislation/Regulation**

### **House Bill 1018**

Requires cities and counties to join the NFIP. The 77th Legislature of the State of Texas amended Subchapter 1, Chapter 16 in the Water Code by adding Section 16.3145 to read as follows: “The governing body of each city and county shall adopt ordinances or orders, as appropriate, necessary for the city or county to be eligible to participate in the National Flood Insurance Program, not later than January 1, 2001”. Was prompted after three Presidential Disaster declarations.

## Resources

### Senate Bill 936

77th legislative session; Allowed counties and general law cities to regulate on the same level as cities are able to. Adoption of more comprehensive floodplain management regulations are now possible, thanks to this bill. The bill also allows counties to collect reasonable fees to cover administrative costs incurred by the administration of a local floodplain management program. It also provides for Criminal and Civil Penalties and injunctive relief.

### House Bill 1445

77th legislature session; Provides regulation of subdivisions in Extraterritorial Jurisdictions (ETJ). It authorizes the municipality and the count to enter into an inter-local agreement to establish floodplain development regulations for plats and subdivisions within the ETJ.

### House Bill 1481

79th legislative session; Barricade law that makes is a criminal offense to cross a barricade at a flooded area.

### Flood Control and Insurance Act

Created in 1969. Stated the need to participate in the 1968 National Flood Insurance Program: "The purpose of this Act is to evidence a positive interest in securing flood insurance coverage under this Federal program, and to so procure for those citizens of Texas desiring to participate; and the promoting of public interest by providing appropriate protection against the perils of flood losses and encouraging sound land use by minimizing exposure of property to flood losses."

### Senate Bill 1601

75th legislature; Relating to utility hookup only being approved once all necessary permits have been completed with the jurisdiction.

